



1

ORGANIZADORES PARA FERRAMENTAS

ORGANIZADORES PARA HERRAMIENTAS

TOOLS STORAGE



A OFICINA DOS SEUS SONHOS EM POUCOS CLIQUES

El taller des tus sueños en pocos cliques |
The workshop of your dreams in just a few clicks

Crie tudo do seu jeito com
a plataforma de simulação 3D da
Tramontina PRO

Creo todo a tu manera con
la plataforma de simulación 3D de
Tramontina PRO

Create everything the way you
want it with the Tramontina PRO
3D simulator.

✓ MONTAGEM E CRIAÇÃO DE OFICINAS PERSONALIZADAS

Montaje y creación de talleres
mecánicos personalizados

Assemble and create
custom workshops

✓ SOLICITE ORÇAMENTO SEM COMPROMISSO

Solicitud de cotización
sin compromiso

Request a free quote

✓ DISPONIBILIDADE DE PROJETOS PRÉ-PRONTOS

Disponibilidad de proyectos
pre-elaborados

Pre-ready projects are available



TRAMONTINA.COM.BR/PRO3D
modulares.gar@tramontina.com

PRO

PASSO A PASSO

PASO A PASO | STEP BY STEP

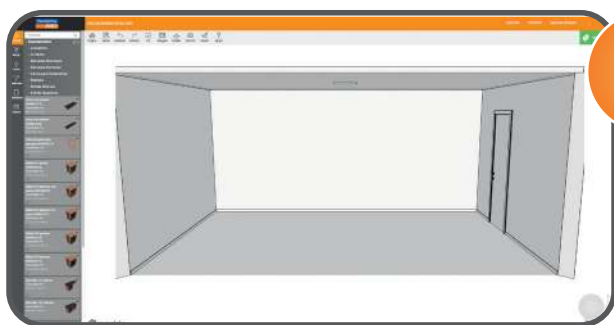

1 CLIQUE EM LAYOUTS E ESCOLHA A DIMENSÃO DAS PAREDES. TAMBÉM ADICIONE ABERTURAS, PORTAS E JANELAS.

Haga clic en layouts y elija la dimensión de las paredes. También agregue aberturas, puertas y ventanas.

Click on layouts and choose the walls dimension. Also add openings, doors and windows.

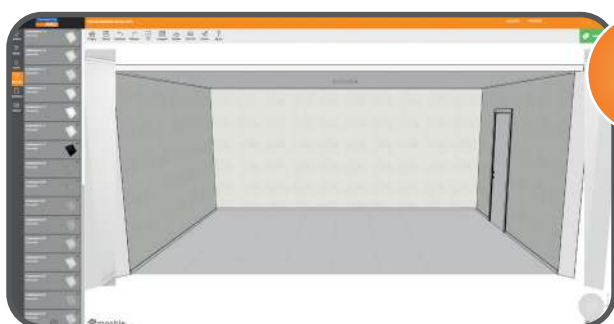

2 PERSONALIZE AS PAREDES, PISOS E TETO CONFORME DESEJAR.

Personalice las paredes, pisos y techo según desee.

Customize the walls, floors and ceiling as you wish.



3 CLIQUE EM MÓVEIS E SELECIONE OS ORGANIZADORES MODULARES DA TRAMONTINA PRO PARA SEU AMBIENTE.

Haga clic en layouts y elija la dimensión de las paredes. También agregue aberturas, puertas y ventanas.

Click on furniture and select Tramontina PRO Modular Organizers for your environment.



4 SELECIONE A COR QUE DESEJAR.

Seleccione el color que desee.

Select the color you want.



5 SALVE SEU PROJETO E SOLICITE ORÇAMENTO SEM COMPROMISSO.

Guarde su proyecto y solicite presupuesto sin compromiso.

Save your project and request a free quote.

TRAMONTINA

PRO

Ferramentas e organizadores para trabalhos de alta performance.

Herramientas y organizadores diseñadas para trabajos de alto desempeño.

Tools and organizers for high-performance jobs.

Inovação e
segurança

Innovación y
seguridad

Innovation and
security



Smart System

CARRO ORGANIZADOR INTELIGENTE

- Organizador inteligente para ferramentas.
- Identificação automática de entradas e saídas.
- Câmeras com sistema de visão.
- Organizador inteligente de ferramentas.
- Identificación automática de entradas y salidas.
- Cámaras con sistema de visión.
- Intelligent tool organizer.
- Automatic identification of entrances and exits.
- Cameras with vision system.



REF.	PESO WEIGHT	Medidas Dimensiones Dimensions (mm)				
		A	B	C	D	E
44971/000	170 kg	1439	967	718	426	652

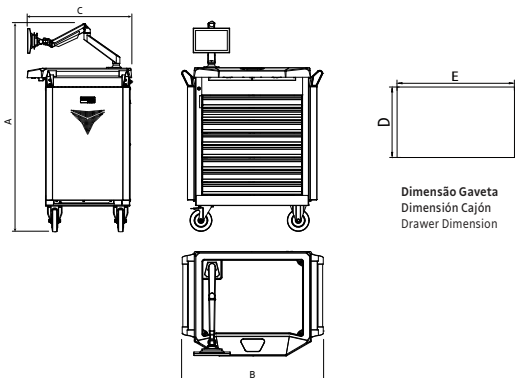

Dimensão Gaveta
Dimensión Cajón
Drawer Dimension



SMART SYSTEM Carro Organizador Inteligente com 8 gavetas

Smart System
CARRO ORGANIZADOR INTELIGENTE

LANÇAMENTO
PORTUGUÊS

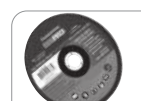

Informações gerais

- Capacidade estática: 400 kg.
- Capacidade dinâmica: 300 kg.
- Capacidade de carga sobre tampo 100 kg.
- Capacidade máxima por gaveta: 15 kg, altura da gaveta 80 mm.
- Gavetas com corrediças telescópicas.
- 2 Rodas giratórias, de borracha com 150 mm de diâmetro, providas de freio.
- 2 Rodas fixas, de borracha com 150 mm de diâmetro.
- Acompanha puxador ergonômico, tampo superior com acabamento em ABS, cor cinza, espessura 3 mm com textura.
- Pintura eletrostática, garantindo acabamento e resistência à corrosão.
- 8 gavetas customizáveis de acordo com suas necessidades, com as ferramentas organizadas em EVA no formato do item.
- Número customizável de ferramentas a ser gerenciadas.

Benefícios

- Trabalho organizado e controle do estoque.
- Crescimento em produtividade e segurança.
- Redução em perda de peças.
- Incremento na responsabilidade organizacional dos colaboradores e na prestação de contas.

Aplicações

- Armazenamento e transporte de ferramentas manuais, peças e acessórios no segmento aeronáutico.
- Controle FOD (Danos por objetos estranhos na aviação).
- Implementação de FME (Exclusão de material estranho na Indústria Elétrica).



Smart System

- Geometria diferenciada contemplando sistema de câmeras e iluminação.
- Dispositivos elétricos e mecânicos convertendo energia em movimento.
- Braço articulado com regulagens para assessorar posição do monitor.
- Ensaio de carga nas gavetas para garantir resistência durante utilização, com 50.000 ciclos abrindo e fechando a gaveta.
- Autonomia mínima de 8,5 horas para abrir e fechar as gavetas em utilização contínua, com possibilidade de recarga.
- Bateria de Lítio ION 24V / 13,2 Ah.
- Carregador Bivolt 110 - 220 V 50/60 Hz - 2,5 A.
- Motores DC 24 V, 11,7 W, 160 rpm, IP40.
- Luminárias Estroboscópica em barra de LED, 24 V, 70 lm.
- Placa Eletrônica CPU 64 bits com 8 Gb de RAM 128 bits LPDDR4x.
- Tecnologia Wifi com protocolo TCP/IP.
- Duas antenas Wireless para incrementar sinal de Wifi 2.4 GHz e 5 GHz.
- Monitor Touchscreen Capacitivo de 10,1" com proporção 16:9.
- Leitor de Cartões RFID.
- Câmeras imagens coloridas, 2,7 W@5V, Resolução 1440 x 1080 pixels, 61 fps.
- Lente Óptica 2,9 mm, 14 mm de diâmetro.
- Reconhecimento das ferramentas por imagem via inteligência artificial e Redes Neurais.
- 90 Gb livre no sistema para gerenciamento dos dados, com possibilidade de limpar a memória quando necessário.
- Interface Touch Screen intuitiva.
- Acesso dos usuários via cartão RFID ou Cartão Ponto.
- Sistema de gerenciamento de usuários com definição de perfis e acessos.
- Gavetas com controle eletrônico individual de abertura e fechamento de acordo com o perfil de acesso.
- Suporte ilimitado para usuários, adiciona e deleta usuários facilmente.
- Fácil identificação de status das gavetas e indicação de ferramentas faltantes.
- Busca inteligente por descrição da peça ou referência Tramontina.
- Certificados de Calibração e manuais de cada ferramenta anexados.
- Histórico de retirada e devoluções de ferramentas.
- Envio do histórico de manuseio para até 3 (três) e-mails.
- Acesso remoto Cliente-Servidor via software com conexão SSH ou HTTPS.
- Tempo programável para encerrar sessão do usuário.
- Atualização do software via sistema.

SMART SYSTEM

Carro Inteligente con 8 cajones



REF.	PESO WEIGHT	Medidas Dimensiones Dimensions (mm)				
		A	B	C	D	E
44971/000	170 kg	1439	967	718	426	652

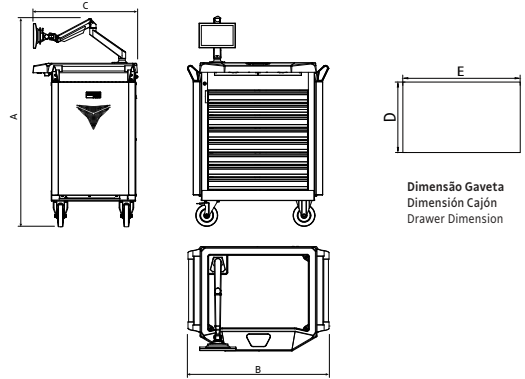

Dimensão Gaveta
Dimensão Cajón
Drawer Dimension

Smart System

Geometría diferenciada que incluye sistema de cámaras e iluminación.
Dispositivos eléctricos y mecánicos que convierten energía en movimiento.
Brazo articulado con ajustes para ayudar a la posición del monitor.
Ensayos de carga en bandejas para garantizar la resistencia durante el uso con 50.000 ciclos de apertura y cierre de bandejas.
Autonomía mínima de 8,5 horas para abrir y cerrar las bandejas en uso continuo con posibilidad de recarga.
Batería de Litio ION 24V / 13,2 Ah.
Cargador Bivolt 110 - 220 V 50/60 Hz - 2,5 A.
Motores DC 24 V, 11,7 W, 160 rpm, IP40.
Luminarias Estroboscópicas en barra de LED, 24 V, 70 lm.
Placa Electrónica CPU 64 bits con 8 Gb de RAM 128 bits LPDDR4x.
Tecnología Wi-Fi con protocolo TCP/IP.
Dos antenas inalámbricas para aumentar la señal de Wi-Fi 2.4 GHz y 5 GHz.
Monitor Touchscreen Capacitivo de 10,1" con proporción 16:9.
Lector de Tarjetas RFID.
Cámaras a color, 2,7 W@5V, Resolución 1440 x 1080 pixeles, 61 fps.
Lente Óptica de 2,9 mm y 14 mm de diámetro.
Reconocimiento de las herramientas por imagen vía inteligencia artificial y Redes Neurales.
90 Gb libre en el sistema para gestión de datos, con posibilidad de limpiar la memoria si fuere necesario.
Interfaz Touch Screen intuitiva.
Acceso de los usuarios mediante tarjeta RFID o Tarjeta de Punto.
Sistema de administración de usuarios con definición de perfiles y accesos.
Bandejas con control electrónico individual de apertura y cierre de acuerdo con el perfil de acceso.
Soporte ilimitado para usuarios, añadir y eliminar usuarios con facilidad.
Fácil identificación del estado de las bandejas e indicación de herramientas faltantes.
Búsqueda inteligente por descripción de la pieza o referencia Tramontina.
Certificados de Calibración y manuales de cada herramienta adjuntos.
Historial de retiro y devoluciones de herramientas.
Envío del historial de manejo para hasta 3 (tres) e-mails.
Acceso remoto Cliente-Servidor mediante software con conexión SSH o HTTPS.
Tiempo programable para finalizar la sesión del usuario.
Actualización del software vía sistema.

Informaciones generales

Capacidad Estática: 400 kg.
Capacidad Dinámica: 300 kg.
Capacidad de carga sobre tapa de 100 kg
Capacidad máxima por bandeja: 15 kg, altura de la bandeja de 80 mm.
Bandejas con correderas telescópicas.
2 Ruedas giratorias de goma con 150 mm de diámetro que incluyen freno.
2 Ruedas fijas de goma con 150 mm de diámetro.
Incluye asa ergonómica, tapa superior con acabado en ABS, color gris, de 3 mm de espesor con textura.
Pintura Electroestática que garantiza acabado y resistencia a la corrosión.
8 cajones personalizables de acuerdo a sus necesidades, con las herramientas organizadas en EVA en el formato del artículo.
Número personalizable de herramientas a gestionar.

Beneficios

Trabajo organizado y control de stock.
Aumento de la productividad y la seguridad.
Reducción de la pérdida de piezas.
Aumento de la responsabilidad organizativa de los empleados y la rendición de cuentas.

Aplicación

- Almacenamiento y transporte de herramientas manuales y accesorios en el segmento aeronáutico.
- Control FOD (Daños por objetos extraños en la aviación).
- Implementación de FME (Exclusión de material extraño en la Industria Eléctrica).



REF.	PESO WEIGHT	Medidas Dimensiones Dimensions (mm)				
		A	B	C	D	E
44971/000	170 kg	1439	967	718	426	652

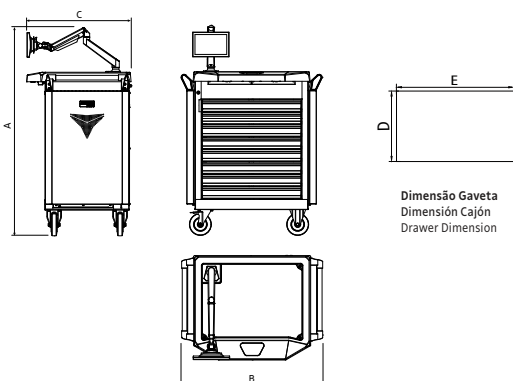

Dimensão Gaveta
Dimensión Cajón
Drawer Dimension

SMART SYSTEM Tool Cabinet with 8 drawers

Smart System
CARRO ORGANIZADOR INTELIGENTE

NEW
INGLÊS

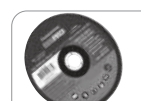

General information

Static Capacity: 400 kg.
Dynamic Capacity: 300 kg.
Load Capacity on Top: 100 kg.
Drawer Capacity: 80 mm high: 15 kg.
Drawers with ball bearing slides.
2 Rubber swivel wheels with a diameter of 150 mm, with brakes.
2 Rubber fixed wheels with a diameter of 150 mm.
Ergonomic handle, top with ABS finishing, gray color, 3mm thick and textured.
Electrostatic painting, providing finishing and resistance to corrosion.
8 customizable drawers according to your needs, with the tools organized in EVA in the format of the item.
Customizable number of tools to be managed.

Benefits

Organized work and stock control.
Increased productivity and safety.
Reduced parts loss.
Increased organizational and employee accountability.

Application

- Storage and transportation of hand tools and accessories in the aeronautical segment.
- Control FOD (Foreign Object Damage in aviation).
- Implementing FME (Foreign Material Exclusion in the power industry).



Smart System

Special geometry contemplating camera and lighting system.
Electrical and mechanical devices converting energy into movement.
Articulated arm with adjustments to assist the monitor's position.
Load tests on the drawers to ensure resistance during use, with 50.000 cycles opening and closing the drawer.
Minimum autonomy of 8.5 hours to open and close the drawers in continuous use, with the possibility of battery recharge.
Li-Ion battery 24V / 13.2 Ah.
Bivolt Charger 110 - 220 V 50/60 Hz - 2.5 A
DC Motor 24V, 11.7 W, 160 rpm, IP40
LED bar stroboscopic luminaires, 24 V, 70 lm.
CPU 64 bits with 8 GB RAM 128 bits LPDDR4x.
Wifi technology with TCP/IP protocol.
Dual wireless antennas for improved connectivity with 2.4 GHz and 5 GHz WIFI signal.
10.1" widescreen, 16:9 LED, capacitive touchscreen.
RFID Reader.
Camera colors images, 2.7 W@5V, resolution 1440 x 1080 pixels, 61 fps.
Optical Lens 2.9 mm, 14 mm diameter.
Image tool detection by artificial intelligence and Neural Networks.
90 Gb free on the system for data management, with possibility to clear the memory when needed.
User-friendly touch screen interface.
User access via RFID card or Time Card.
User management system with defined profiles and accesses.
Drawers with individual electronic control of opening and closing according to the access profile.
Unlimited user support, easily add and delete users.
Easy to understand status displays.
Automatic identification of the pickup and return of the tools with historical record.
Intelligent search by part description or Tramontina reference.
Included are the calibration certificates or manuals for each tool.
Historical pickup and return of tools.
Transmission of the manipulation logs to up to 3 (three) e-mails.
Client-Server remote access by software with SSH or HTTPS connection.
Programmable time for user logout.
Software update by system.

COMO MONTAR SUA BANCADA MODULAR

Como montar su bancada modular |
How to assemble your modular workbench

1º

ESCOLHA O MATERIAL DO TAMPO

Elija el material de la tapa. / Choose the material of the worktop.



Tampo de metal |
Tapa metálica |
Metal worktop



Tampo de madeira em compensado naval |
Tapa de madeira naval |
Shipbuilding wood worktop



Tampo de madeira em pinus |
Tapa de madeira de pinus |
Pinus wood worktop

2º

ESCOLHA O TAMANHO DO TAMPO

Elija el tamaño de la tapa. / Choose the size of the worktop.



Tampo de metal |
Tapa metálica | Metal worktop
Comprimento | largo | length: 1,6 m



Tampo de metal para módulo de canto L |
Tapa metálica para módulo de esquina L |
Metal worktop for L corner workbench



Tampo de madeira em compensado naval |
Tapa de madeira naval | Shipbuilding wood worktop
Comprimento | largo | length: 1,6 m
Comprimento | largo | length: 2,4 m



Tampo de madeira em compensado naval para módulo de canto L |
Tapa de madeira naval para módulo de esquina L |
Shipbuilding wood worktop for L corner workbench



Tampo de madeira de pinus |
Tapa de madeira de pinus | Pinus wood worktop
Comprimento | largo | length: 1,6 m
Comprimento | largo | length: 2,4 m



Tampo de madeira de pinus para módulo de canto L |
Tapa de madeira de pinus para módulo de esquina L |
Pinus wood worktop for L corner workbench

3^o

ESCOLHA OS MÓDULOS

Elija los módulos. / Choose the modular units.



Perna de apoio |
Pata de apoyo |
Workbench leg



Módulo 2 portas |
Modulo 2 puertas |
2 doors modular unit



Módulo 2 portas e 3 gavetas |
Modulo 2 puertas y 3 cajones |
2 doors and 3 drawers modular unit



Módulo 1 porta e 5 gavetas |
Módulo 1 puerta y 5 cajones |
1 door and 5 drawers modular unit



Módulo 7 gavetas |
Módulo 7 cajones |
7 drawers modular unit



Módulo 8 gavetas |
Módulo 8 cajones |
8 drawers modular unit



Módulo de canto em L com 1 porta |
Modulo de esquina L con 1 puerta |
1 door modular unit for L corner
workbench

4^o

EXEMPLO DE MONTAGEM

Ejemplos de montaje. / Assembling examples.



Comprimento 1,6 m
Largo 1,6 m
Lenght 1,6 m



Comprimento 1,6 m
Largo 1,6 m
Lenght 1,6 m



Comprimento 2,4 m
Largo 2,4 m
Lenght 2,4 m



Tampo de madeira em compensado naval

Tapa de madera naval | Shipbuilding wood worktop



Tampo de madeira em compensado naval.
Acabamento envernizado.

Tapa de madera naval.
Acabado barnizado.

Shipbuilding wood worktop.
Varnished finishing.

Comprimento | Longitud | Length:

44954/017 - 1.600 mm

44954/018 - 2.400 mm

REF.	PESO WEIGHT	Medidas Dimensiones Dimensions (mm)		
		A	B	C
44954/017	42,00 kg	40	1.600	650
44954/018	63,50 kg	40	2.400	650

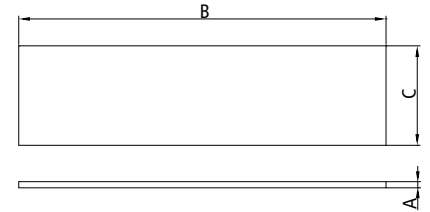

Tampo de metal

Tapa metálica | Metal worktop



Tampo metálico.
Pintura eletroestática na cor preta.

Tapa en metal.
Pintura electrostática.

Metal worktop.
Electrostatic painting in Black color.

Comprimento | Longitud | Length:

44954/019 - 1.600 mm

REF.	PESO WEIGHT	Medidas Dimensiones Dimensions (mm)		
		A	B	C
44954/019	42,00 kg	40	1.600	650

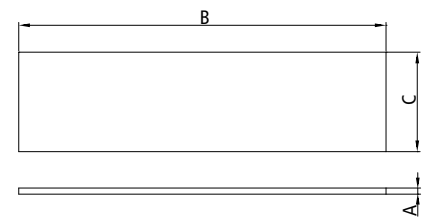

Tampo de madeira de pinus

Tapa de madera de pinus | Pinus wood worktop



Tampo em laminado de Pinus.
Acabamento envernizado.

Tapa de Laminado de Pinus.
Acabado barnizado.

Laminated Pinus worktop.
Varnished finishing.

Comprimento | Longitud | Length:

44954/022 - 1.600 mm

44954/023 - 2.400 mm

REF.	PESO WEIGHT	Medidas Dimensiones Dimensions (mm)		
		A	B	C
44954/022	32,00 kg	40	1.600	650
44954/023	50,00 kg	40	2.400	650

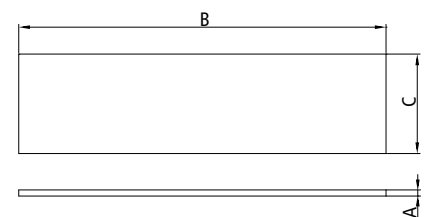

REF.	PESO WEIGHT	Medidas Dimensiones Dimensions (mm)		
		A	B	C
44954/025	48,00 kg	960	960	40

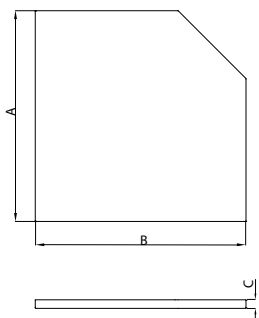

Tampo de madeira em compensado naval para bancada de canto L

Tapa de madeira naval para bancada de esquina L |
Shipbuilding wood worktop for L corner workbench



Tampo de madeira em compensado naval.
Acabamento envernizado.

Tapa de madeira naval.
Acabado barnizado.

Shipbuilding wood worktop.
Varnished finishing.

REF.	PESO WEIGHT	Medidas Dimensiones Dimensions (mm)		
		A	B	C
44954/026	38,00 kg	960	960	40

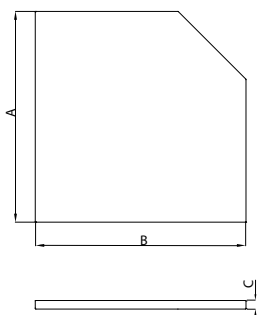

Tampo metálico para bancada de canto L

Tapa metálica para bancada de esquina L |
Metal worktop for L corner workbench



Tampo metálico.
Pintura eletroestática na cor preta.

Tapa en metal.
Pintura electrostática.

Metal worktop.
Electrostatic painting in Black color.

REF.	PESO WEIGHT	Medidas Dimensiones Dimensions (mm)		
		A	B	C
44954/027	38,00 kg	960	960	40

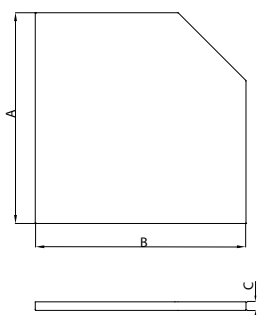

Tampo de madeira de pinus para bancada de canto L

Tapa de madeira pinus para bancada de esquina L |
Pinus wood worktop for L corner workbench



Tampo em laminado de Pinus.
Acabamento envernizado.

Tapa de Laminado de Pinus.
Acabado barnizado.

Laminated Pinus worktop.
Varnished finishing.



Perna de apoio para bancada

Pata de apoyo para bancada | Workbench leg



REF.	PESO WEIGHT	Medidas Dimensiones Dimensions (mm)		
		A	B	C
● 44954/014	6,30 kg	857	590	80
● 44954/214	6,30 kg	857	590	80
● 44954/314	6,30 kg	857	590	80
● 44954/414	6,30 kg	857	590	80

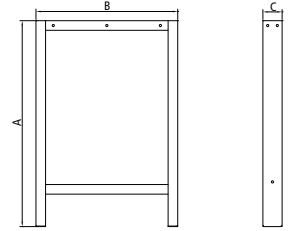

Estrutura em chapas de aço conformadas.
Espessuras das chapas de 1,2 mm.
Pintura eletrostática.

Estructura en chapas de acero conformadas.
Espesor de las chapas de 1,2 mm.
Pintura electrostática.

Conformed steel sheets structure.
1.2 mm sheet thickness.
Electrostatic painting.

Cores disponíveis
Colores disponibles
Available colors:



Não configure a sua bancada modular apenas com pernas de apoio, tal configuração requer reforços conforme modelos da página 51.

No ensamble la bancada solamente con las patas de apoyo, esta configuración requiere refuerzos como los modelos de la página 51.

Do not assemble your workbench just with the workbench legs, this configuration requires reinforcements as models form page 51.



REF.	PESO WEIGHT	Medidas Dimensiones Dimensions (mm)		
		A	B	C
● 44954/052	100,00 kg	860	900	900
● 44954/252	100,00 kg	860	900	900
● 44954/352	100,00 kg	860	900	900
● 44954/452	100,00 kg	860	900	900

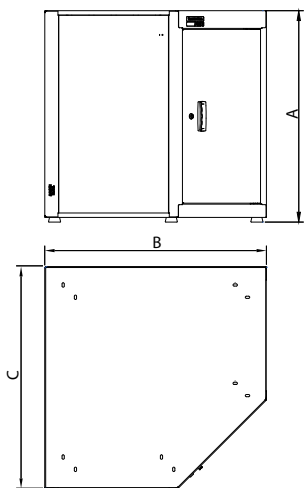

Módulo para bancada de canto L com 1 porta

Módulo para bancada de esquina L con 1 puerta

Modular unit for L corner workbench with 1 door



Cores disponíveis
Colores disponibles
Available colors:



Estrutura em chapas de aço conformadas.
1 porta com abertura de 100°.
Tranca para a porta.
Pintura eletrostática.
Capacidade de carga máxima distribuída: 800 kg.
Capacidade de carga distribuída da prateleira: 60 kg.
Espessuras das chapas do corpo: 1,2 mm.
Espessuras das chapas da porta: 0,9 mm.
Compatível com os tampos Tramontina PRO 44954/025, 44954/026 e 44954/027.

Estructura en chapas de acero conformadas.
Una puerta con apertura de 100°.
Traba para la puerta.
Pintura electrostática.
Capacidad de carga máxima repartida: 800 kg;
Capacidad de carga repartida máxima de la estante: 60 kg;
Espesor de las chapas de la estructura: 1,2 mm.
Espesor de las chapas de la puerta: 0,9 mm.
Compatible con las tapas Tramontina PRO 44954/025, 44954/026 y 44954/027.

Conformed steel sheets structure.
One door with 100° opening.
Lock for the door.
Electrostatic painting.
Maximum distributed load capacity: 800 kg.
Maximum distributed rack capacity: 60 kg.
Structure sheet thickness: 1.2 mm.
Doors sheet thickness: 0.9 mm.
Compatible with Tramontina PRO worktops 44954/025; 44954/026 and 44954/027.



Pés de regulagem de altura, para compensar irregularidades no piso.

Pies de ajuste de altura para compensar las irregularidades del suelo.

Adjustable feet for height adjustment when floors are irregular.



Tranca para as portas com chave e puxador de plástico.

Cierre con llave para las puertas y tirador de plástico.

Doors with key locking system and plastic handle.



Prateleira interna para melhor acomodação das ferramentas.

Estante en la parte interior para un mejor alojamiento de las herramientas.

Internal rack for better tools accommodation.

Aplicações | Aplicación | Application

- Armazenamento de ferramentas manuais e base de trabalho para manutenção de peças.
- Específico para montagens em cantos com ângulo de 90°.
- Almacenamiento de herramientas manuales y base de trabajo para mantenimiento de piezas.
- Específico para montaje en esquinas con ángulo de 90°.
- Storage of hand tools and work base for tools maintenance.
- Specific for assemblies in corners with 90° angle.



Módulo 5 gavetas e 1 porta

Módulo 5 cajones y 1 puerta

Modular unit with 5 drawers and 1 door



REF.	PESO WEIGHT	Medidas Dimensiones Dimensions (mm)				
		A	B	C	D	E
● 44954/011	69,10 kg	860	773	552	420	645
● 44954/211	69,10 kg	860	773	552	420	645
● 44954/311	69,10 kg	860	773	552	420	645
● 44954/411	69,10 kg	860	773	552	420	645

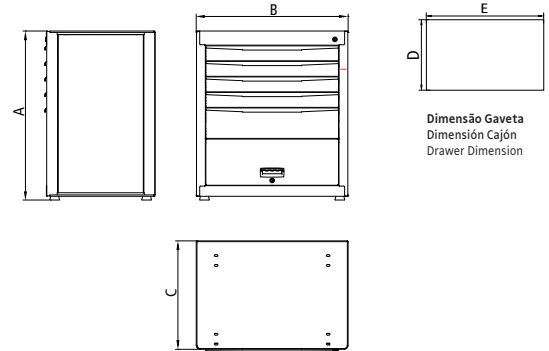

Dimensão Gaveta
Dimensión Cajón
Drawer Dimension

Estrutura em chapas de aço conformadas.

5 gavetas com corrediças telescópicas.

1 porta com abertura de 90°.

Tranca para a porta e gavetas.

Pintura eletrostática.

Capacidade de carga máxima gavetas com altura de 75 mm: 20 kg.

Capacidade de carga máxima gavetas com altura de 155 mm: 30 kg.

Espessuras das chapas do corpo e gavetas: 1,2 mm.

Espessuras das chapas da porta: 0,9 mm.

Estructura en chapas de acero conformadas.

Cinco cajones con rieles telescópicos.

Una puerta con apertura de 90°.

Traba para la puerta y los cajones.

Pintura electrostática.

Capacidad de carga máxima cajón con 75 mm de altura: 20 kg.

Capacidad de carga máxima cajón con 155 mm de altura: 30 kg.

Espesor de las chapas de la estructura y cajones: 1,2 mm.

Espesor de las chapas de la puerta: 0,9 mm.

Conformed steel sheets structure.

Five drawers with ball bearing slides.

One door with 90° opening.

Locks for the door and drawers.

Electrostatic painting.

Maximum load capacity of 75 mm drawer: 20 kg.

Maximum load capacity of 155 mm drawer: 30 kg.

Structure and drawers sheet thickness: 1.2 mm.

Doors sheet thickness: 0.9 mm.

Cores disponíveis
Colores disponibles
Available colors:



Pés de regulagem de altura,
para compensar irregularidades
no piso.

Pies de ajuste de altura para
compensar las irregularidades
del suelo.

Adjustable feet for height
adjustment when floors are
irregular.



Trancas para as gavetas e porta.

Traba para los cajones y puerta.

Door and drawers with key locking
system.



Sistema especial de travamento
de gavetas.

Sistema especial de traba de
los cajones.

Special system to lock the
drawers.



Corrediças telescópicas que
garantem maior abertura da
gaveta.

Rieles telescópicos que
garantizan mayor apertura
del cajón.

Ball bearing slides that assure
allow maximum of the drawer
opening.

Aplicações | Aplicación | Application

- Armazenamento de ferramentas manuais.
- Almacenamiento de herramientas manuales.
- Storage of hand tools.

REF.	PESO WEIGHT	Medidas Dimensiones Dimensions (mm)				
		A	B	C	D	E
44954/012	66,50 kg	860	773	552	420	645
44954/212	66,50 kg	860	773	552	420	645
44954/312	66,50 kg	860	773	552	420	645
44954/412	66,50 kg	860	773	552	420	645

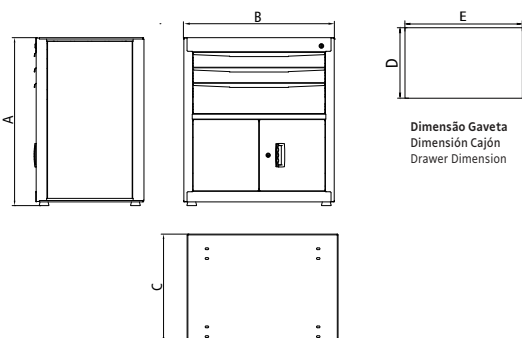

Cores disponíveis
Colores disponibles
Available colors:



Pés de regulagem de altura,
para compensar irregularidades
no piso.

Pies de ajuste de altura para
compensar las irregularidades
del suelo.

Adjustable feet for height
adjustment when floors are
irregular.



Corrediças telescópicas que
garantem maior abertura da
gaveta.

Rieles telescópicos que
garantizan mayor apertura
del cajón.

Ball bearing slides that assure
allow maximum of the drawer
opening.



Trancas para as gavetas e porta.

Traba para los cajones y puerta.

Door and drawers with key locking
system.



Sistema especial de travamento
de gavetas.

Sistema especial de traba de
los cajones.

Special system to lock the
drawers.

Módulo 3 gavetas e 2 portas

Módulo 3 cajones y 2 puertas

Modular unit with 3 drawers and 2 doors



Estrutura em chapas de aço conformadas.

3 gavetas com corrediças telescópicas.

2 portas com abertura de 100°.

Tranca para as portas e gavetas.

Pintura eletrostática.

Capacidade de carga máxima gavetas com altura de 75 mm: 20 kg.

Capacidade de carga máxima gavetas com altura de 155 mm: 30 kg.

Espessuras das chapas do corpo e gavetas: 1,2 mm.

Espessuras das chapas da porta: 0,9 mm.

Estructura en chapas de acero conformadas.

Tres cajones con rieles telescópicos.

Dos puertas con apertura de 100°.

Traba para las puertas y cajones.

Pintura electrostática.

Capacidad de carga máxima cajón con 75 mm de altura: 20 kg.

Capacidad de carga máxima cajón con 155 mm de altura: 30 kg.

Espesor de las chapas de la estructura y cajones: 1,2 mm.

Espesor de las chapas de la puerta: 0,9 mm.

Conformed steel sheets structure.

Three drawers with ball bearing slides.

Two doors with 100° opening.

Locks for the door and drawers.

Electrostatic painting.

Maximum load capacity of 75 mm drawer: 20 kg.

Maximum load capacity of 155 mm drawer: 30 kg.

Structure and drawers sheet thickness: 1.2 mm.

Doors sheet thickness: 0.9 mm.

Aplicações | Aplicación | Application

- Armazenamento de ferramentas manuais.
- Almacenamiento de herramientas manuales.
- Storage of hand tools.



Módulo 7 gavetas

Módulo 7 cajones | Modular unit with 7 drawers



REF.	PESO WEIGHT	Medidas Dimensiones Dimensions (mm)				
		A	B	C	D	E
44954/013	88,50 kg	860	773	552	420	645
44954/213	88,50 kg	860	773	552	420	645
44954/313	88,50 kg	860	773	552	420	645
44954/413	88,50 kg	860	773	552	420	645

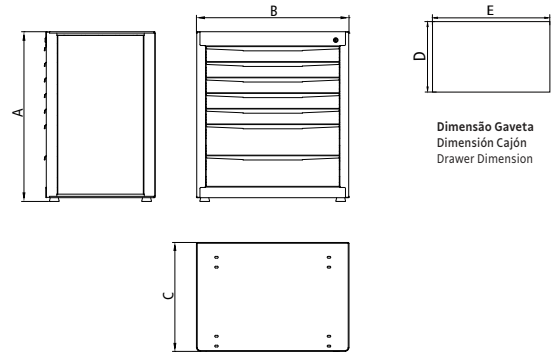

Dimensão Gaveta
Dimensión Cajón
Drawer Dimension

Estrutura em chapas de aço conformadas.

7 gavetas com corrediças telescópicas.

Tranca para as gavetas.

Pintura eletrostática.

Capacidade de carga máxima gavetas com altura de 75 mm: 20 kg.

Capacidade de carga máxima gavetas com altura de 155 mm: 30 kg.

Espessuras das chapas do corpo e gavetas: 1,2 mm.

Estructura en chapas de acero conformadas.

Siete cajones con rieles telescópicos.

Traba para los cajones.

Pintura electrostática.

Capacidad de carga máxima cajón con 75 mm de altura: 20 kg.

Capacidad de carga máxima cajón con 155 mm de altura: 30 kg.

Espesor de las chapas de la estructura y cajones: 1,2 mm.

Conformed steel sheets structure.

Seven drawers with ball bearing slides.

Locks for the drawers.

Electrostatic painting.

Maximum load capacity of 75 mm drawer: 20 kg.

Maximum load capacity of 155 mm drawer: 30 kg.

Structure and drawers sheet thickness: 1.2 mm.

Cores disponíveis
Colores disponibles
Available colors:



Pés de regulagem de altura, para compensar irregularidades no piso.

Pies de ajuste de altura para compensar las irregularidades del suelo.

Adjustable feet for height adjustment when floors are irregular.



Trancas para as gavetas e porta.

Traba para los cajones y puerta.

Door and drawers with key locking system.



Sistema especial de travamento de gavetas.

Sistema especial de traba de los cajones.

Special system to lock the drawers.



Corrediças telescópicas que garantem maior abertura da gaveta.

Rieles telescópicos que garantizan mayor apertura del cajón.

Ball bearing slides that assure allow maximum of the drawer opening.

Aplicações | Aplicación | Application

- Armazenamento de ferramentas manuais.
- Almacenamiento de herramientas manuales.
- Storage of hand tools.



REF.	PESO WEIGHT	Medidas Dimensiones Dimensions (mm)				
		A	B	C	D	E
● 44954/015	88,50 kg	860	773	552	420	645
● 44954/215	88,50 kg	860	773	552	420	645
● 44954/315	88,50 kg	860	773	552	420	645
● 44954/415	88,50 kg	860	773	552	420	645

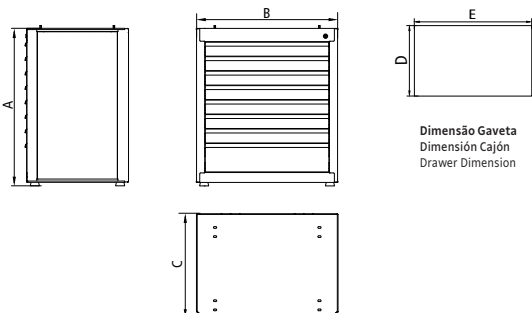

Dimensão Gaveta
Dimensión Cajón
Drawer Dimension

Cores disponíveis
Colores disponibles
Available colors:



Módulo 8 gavetas

Módulo 8 cajones | Modular unit with 8 drawers



Estrutura em chapas de aço conformadas.
8 gavetas com corrediças telescópicas.

Tranca para as gavetas.

Pintura eletrostática.

Capacidade de carga máxima gavetas com altura de 75 mm: 20 kg.

Capacidade de carga máxima gavetas com altura de 155 mm: 30 kg.

Espessuras das chapas do corpo e gavetas: 1,2 mm.

Estructura en chapas de acero conformadas.

Ocho cajones con rieles telescópicos.

Traba para las puertas y cajones.

Pintura electrostática.

Capacidad de carga máxima cajón con 75 mm de altura: 20 kg.

Capacidad de carga máxima cajón con 155 mm de altura: 30 kg.

Espesor de las chapas de la estructura y cajones: 1,2 mm.

Conformed steel sheets structure.

Eight drawers with ball bearing slides.

Locks for the door and drawers.

Electrostatic painting.

Maximum load capacity of 75 mm drawer: 20 kg.

Maximum load capacity of 155 mm drawer: 30 kg.

Structure and drawers sheet thickness: 1.2 mm.



Pés de regulagem de altura,
para compensar irregularidades
no piso.

Pies de ajuste de altura para
compensar las irregularidades
del suelo.

Adjustable feet for height
adjustment when floors are
irregular.



Trancas para as gavetas e porta.

Traba para los cajones y puerta.

Door and drawers with key locking
system.



Sistema especial de travamento
de gavetas.

Sistema especial de traba de
los cajones.

Special system to lock the
drawers.



Corrediças telescópicas que
garantem maior abertura da
gaveta.

Rieles telescópicos que
garantizan mayor apertura
del cajón.

Ball bearing slides that assure
allow maximum of the drawer
opening.

Aplicações | Aplicación | Application

- Armazenamento de ferramentas manuais.
- Almacenamiento de herramientas manuales.
- Storage of hand tools.



Módulo 2 portas

Módulo 2 puertas | Modular unit with 2 doors



REF.	PESO WEIGHT	Medidas Dimensiones Dimensions (mm)		
		A	B	C
● 44954/016	48,50 kg	860	773	552
● 44954/216	48,50 kg	860	773	552
● 44954/316	48,50 kg	860	773	552
● 44954/416	48,50 kg	860	773	552

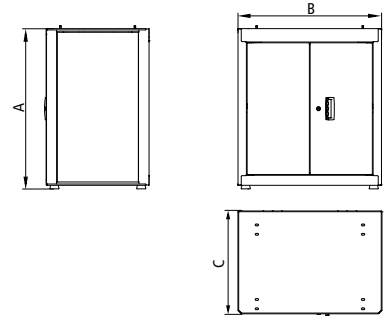

Estrutura em chapas de aço conformadas.
Prateleira interna com regulagem de altura.
2 portas com abertura de 100°.
Tranca para as portas.
Pintura eletrostática.
Capacidade de carga máxima da prateleira: 60 kg.
Espessuras das chapas do corpo: 1,2 mm.

Estructura en chapas de acero conformadas.
Estante interna con ajuste de altura.
2 puertas con abertura de 100°.
Traba para las puertas.
Pintura electrostática.
Capacidad de carga máxima para la estante: 60 kg.
Espesor de las chapas de la estructura: 1,2 mm.

Conformed steel sheets structure.
Internal rack with height adjustment.
2 doors with 100° opening.
Lock for the doors.
Electrostatic painting.
Maximum load capacity for rack: 60 kg.
Structure sheet thickness: 1.2 mm.

Cores disponíveis
Colores disponibles
Available colors:



Pés de regulagem de altura, para compensar irregularidades no piso.

Pies de ajuste de altura para compensar las irregularidades del suelo.

Adjustable feet for height adjustment when floors are irregular.



Tranca para as portas com chave e puxador de plástico.

Cierre con llave para las puertas y tirador de plástico.
Doors with key locking system and plastic handle.



Prateleiras móveis que possibilitam diferentes configurações de montagem.

Estantes móveis que permiten diferentes configuraciones de montaje.

Mobile racks that enables different mounting configurations



Aplicações | Aplicación | Application

- Armazenamento de ferramentas manuais.
- Almacenamiento de herramientas manuales.
- Storage of hand tools.



REF.	PESO WEIGHT	Descrição Descripción Description
44954/012	66,50 kg	Módulo 3 gavetas e 2 portas Módulo 3 cajones y 2 puertas Modular unit with 3 drawers and 2 doors
44954/014	6,30 kg	Perna de apoio para bancada Pata de apoyo para bancada Workbench leg
44954/017	42,00 kg	Tampo de madeira em compensado naval 1.600 mm Tapa de madera naval 1.600 mm 1.600 mm shipbuilding wood worktop

Materiais disponíveis para os tamos | Materiales disponibles para las tapas | Materials available for the tops:

-  Tampo de madeira em compensado naval | Tapa de madera naval | Shipbuilding wood worktop
-  Tampo de metal | Tapa metálica | Metal worktop
-  Tampo de madeira em pinus | Tapa de madera de pinus | Pinus wood worktop

Cores disponíveis para os módulos | Colores disponibles para módulos | Available colors for modules:



Bancada - 1 módulo

Bancada - 1 Módulo | Workbench - 1 modular unit
Tamanho | Tamaño | Size: 1,6 m





Informações técnicas nas páginas |
Informaciones técnicas en las páginas |
Technical information on pages: 38, 40, 43.



REF.	PESO WEIGHT	Descrição Descripción Description
44954/012	66,50 kg	Módulo 3 gavetas e 2 portas Módulo 3 cajones y 2 puertas Modular unit with 3 drawers and 2 doors
44954/013	66,50 kg	Módulo 7 gavetas Módulo 7 cajones Modular unit with 7 drawers
44954/017	42,00 kg	Tampo de madeira em compensado naval 1.600 mm Tapa de madera naval 1.600 mm 1.600 mm shipbuilding wood worktop

Materiais disponíveis para os tamos | Materiales disponibles para las tapas | Materials available for the tops:

-  Tampo de madeira em compensado naval | Tapa de madera naval | Shipbuilding wood worktop
-  Tampo de metal | Tapa metálica | Metal worktop
-  Tampo de madeira em pinus | Tapa de madera de pinus | Pinus wood worktop

Cores disponíveis para os módulos | Colores disponibles para módulos | Available colors for modules:



Bancada - 2 módulos



Bancada - 2 Módulos | Workbench - 2 modular units
Tamanho | Tamaño | Size: 1,6 m



Informações técnicas nas páginas |
Informaciones técnicas en las páginas |
Technical information on pages: 38, 43, 44.

REF.	PESO WEIGHT	Descrição Descripción Description
44954/011	69,10 kg	Módulo 5 gavetas e 1 porta Módulo 5 cajones y 1 puerta Modular unit with 5 drawers and 1 door
44954/012	66,50 kg	Módulo 3 gavetas e 2 portas Módulo 3 cajones y 2 puertas Modular unit with 3 drawers and 2 doors
44954/017	66,50 kg	Tampo de madeira em compensado naval 1.600 mm Tapa de madera naval 1.600 mm 1.600 mm shipbuilding wood worktop

Materiais disponíveis para os tamos | Materiales disponibles para las tapas | Materials available for the tops:

-  Tampo de madeira em compensado naval | Tapa de madera naval | Shipbuilding wood worktop
-  Tampo de metal | Tapa metálica | Metal worktop
-  Tampo de madeira em pinus | Tapa de madera de pinus | Pinus wood worktop

Cores disponíveis para os módulos | Colores disponibles para módulos | Available colors for modules:



Bancada - 2 módulos

Bancada - 2 Módulos | Workbench - 2 modular units
Tamanho | Tamaño | Size: 1,6 m



Informações técnicas nas páginas |
Informaciones técnicas en las páginas |
Technical information on pages: 38, 42, 43.

Bancada - 2 módulos

Bancada - 2 Módulos | Workbench - 2 modular units
Tamanho | Tamaño | Size: **1,6 m**



Informações técnicas nas páginas |
Informaciones técnicas en las páginas |
Technical information on pages: **38, 43, 46.**

REF.	PESO WEIGHT	Descrição Descripción Description
44954/012	66,50 kg	Módulo 3 gavetas e 2 portas Módulo 3 cajones y 2 puertas Modular unit with 3 drawers and 2 doors
44954/016	69,10 kg	Módulo 2 portas Módulo 2 puertas Modular unit with 2 doors
44954/017	42,00 kg	Tampo de madeira em compensado naval 1.600 mm Tapa de madera naval 1.600 mm 1.600 mm shipbuilding wood worktop

Materials disponíveis para os tamos | Materiales disponibles para las tapas | Materials available for the tops:

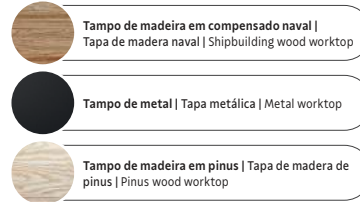

Cores disponíveis para os módulos | Colores disponibles para módulos | Available colors for modules:

**Bancada - 2 módulos**

Bancada - 2 Módulos | Workbench - 2 modular units
Tamanho | Tamaño | Size: **2,4 m**



Informações técnicas nas páginas |
Informaciones técnicas en las páginas |
Technical information on pages: **38, 42, 44.**

REF.	PESO WEIGHT	Descrição Descripción Description
44954/011	69,10 kg	Módulo 5 gavetas e 1 porta Módulo 5 cajones y 1 puerta Modular unit with 5 drawers and 1 door
44954/013	69,10 kg	Módulo 7 gavetas Módulo 7 cajones 7 Modular unit with 7 drawers
44954/018	63,50 kg	Tampo de madeira em compensado naval 2.400 mm Tapa de madera naval 2.400 mm 2.400 mm shipbuilding wood worktop

Materials disponíveis para os tamos | Materiales disponibles para las tapas | Materials available for the tops:

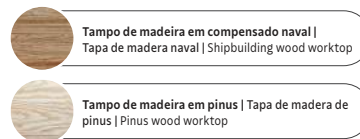

Cores disponíveis para os módulos | Colores disponibles para módulos | Available colors for modules:

**Bancada - 2 módulos**

Bancada - 2 Módulos | Workbench - 2 modular units
Tamanho | Tamaño | Size: **2,4 m**



Informações técnicas nas páginas |
Informaciones técnicas en las páginas |
Technical information on pages: **38, 42, 43.**

REF.	PESO WEIGHT	Descrição Descripción Description
44954/011	69,10 kg	Módulo 5 gavetas e 1 porta Módulo 5 cajones y 1 puerta Modular unit with 5 drawers and 1 door
44954/012	66,50 kg	Módulo 3 gavetas e 2 portas Módulo 3 cajones y 2 puertas Modular unit with 3 drawers and 2 doors
44954/018	63,50 kg	Tampo de madeira em compensado naval 2.400 mm Tapa de madera naval 2.400 mm 2.400 mm shipbuilding wood worktop

Materials disponíveis para os tamos | Materiales disponibles para las tapas | Materials available for the tops:

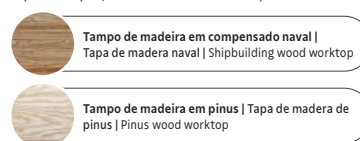



Cores disponíveis para os módulos | Colores disponibles para módulos | Available colors for modules:



REF.	PESO WEIGHT	Descrição Descripción Description
44954/011	69,10 kg	Módulo 5 gavetas e 1 porta Módulo 5 cajones y 1 puerta Modular unit with 5 drawers and 1 door
44954/012	69,10 kg	Módulo 3 gavetas e 2 portas Módulo 3 cajones y 2 puertas Modular unit with 3 drawers and 2 doors
44954/013	66,50 kg	Módulo 7 gavetas Módulo 7 cajones Modular unit with 7 drawers
44954/018	63,50 kg	Tampo de madeira em compensado naval 2.400 mm Tapa de madera naval 2.400 mm 2.400 mm shipbuilding wood worktop

Materials disponíveis para os tampos | Materiales disponibles para las tapas | Materials available for the tops:

-  Tampo de madeira em compensado naval | Tapa de madera naval | Shipbuilding wood worktop
-  Tampo de madeira em pinus | Tapa de madera de pinus | Pinus wood worktop

Cores disponíveis para os módulos | Colores disponibles para módulos | Available colors for modules:



Bancada - 3 módulos

Bancada - 3 Módulos | Workbench - 3 modular units
Tamanho | Tamaño | Size: 2,4 m





Informações técnicas nas páginas |
Informaciones técnicas en las páginas |
Technical information on pages: 38, 42, 43, 44.



REF.	PESO WEIGHT	Descrição Descripción Description
44954/011	69,10 kg	Módulo 5 gavetas e 1 porta Módulo 5 cajones y 1 puerta Modular unit with 5 drawers and 1 door
44954/012	69,10 kg	Módulo 3 gavetas e 2 portas Módulo 3 cajones y 2 puertas Modular unit with 3 drawers and 2 doors
44954/015	88,50 kg	Módulo 8 gavetas Módulo 8 cajones Modular unit with 8 drawers
44954/018	63,50 kg	Tampo de madeira em compensado naval 2.400 mm Tapa de madera naval 2.400 mm 2.400 mm shipbuilding wood worktop

Materials disponíveis para os tampos | Materiales disponibles para las tapas | Materials available for the tops:

-  Tampo de madeira em compensado naval | Tapa de madera naval | Shipbuilding wood worktop
-  Tampo de madeira em pinus | Tapa de madera de pinus | Pinus wood worktop

Cores disponíveis para os módulos | Colores disponibles para módulos | Available colors for modules:



Bancada - 3 módulos

Bancada - 3 Módulos | Workbench - 3 modular units
Tamanho | Tamaño | Size: 2,4 m



Informações técnicas nas páginas |
Informaciones técnicas en las páginas |
Technical information on pages: 38, 42, 43, 45.



Bancada aberta

Bancada | Workbench



Tampo de 1,6 m em madeira com espessura de 40 mm.
Estrutura em chapas de aço conformadas.
2 gavetas com corrediças telescópicas.
Trancas para as gavetas.
Capacidade de carga máxima por gaveta: 30 kg.
Capacidade de carga total: 1.400 kg.
Espessuras das chapas: 1,2 mm.
Pintura eletrostática.

Tapa de 1,6 m em madeira con espesor de 40 mm.
Estructura en chapas de acero conformadas.
Dos cajones con rieles telescópicos.
Traba para los cajones.
Capacidad de carga máxima por cajón: 30 kg.
Capacidad total de carga: 1.400 kg.
Espesor de las chapas: 1,2 mm.
Pintura electrostática.

1.6 m length wood worktop with 40 mm thickness.
Conformed steel sheets structure.
Two drawers with ball bearing slides.
Lock for the drawers.
Drawer capacity: 30 kg.
Total load capacity: 1.400 kg.
Sheet thickness: 1.2 mm.
Electrostatic painting.

REF.	PESO WEIGHT	Medidas Dimensiones Dimensions (mm)				
		A	B	C	D	E
44954/040	81,40 kg	900	1.600	650	1.426	590
44954/240	81,40 kg	900	1.600	650	1.426	590
44954/340	81,40 kg	900	1.600	650	1.426	590
44954/440	81,40 kg	900	1.600	650	1.426	590

2 GAVETAS
CAJONES
DRAWERS

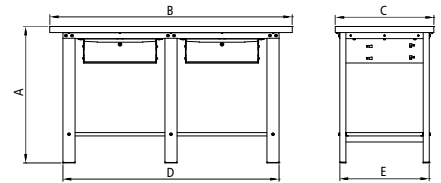

Cores disponíveis
Colores disponibles
Available colors:



Aplicações | Aplicación | Application

- Armazenamento de ferramentas manuais e base de trabalho para manutenção de peças.
- Almacenamiento de herramientas manuales y base de trabajo para mantenimiento de piezas.
- Storage of hand tools and work base for tools maintenance.

Bancada aberta com tampo metálico

Bancada con tapa de metal | Metal workbench



Tampo metálico de 1,6 m com espessura de 1,9 mm.
Estrutura em chapas de aço conformadas.
2 gavetas com corrediças telescópicas.
Trancas para as gavetas.
Capacidade de carga máxima por gaveta: 30 kg.
Capacidade de carga total: 400 kg.
Espessuras das chapas das pernas: 1,9 mm.
Pintura eletrostática.

Tapa de 1,6 m em metal con espesor de 1,9 mm.
Estructura en chapas de acero conformadas.
Dos cajones con rieles telescópicos.
Traba para los cajones.
Capacidad de carga máxima por cajón: 30 kg.
Capacidad total de carga: 400 kg.
Espesor de las chapas de las pernas: 1,9 mm.
Pintura electrostática.

1.6 m length metal worktop with 1.9 mm thickness.
Conformed steel sheets structure.
Two drawers with ball bearing slides.
Lock for the drawers.
Drawer capacity: 30 kg.
Total load capacity: 400 kg.
Sheet thickness for the legs: 1.9 mm.
Electrostatic painting.

REF.	PESO WEIGHT	Medidas Dimensiones Dimensions (mm)		
		A	B	C
44954/045	83,50 kg	900	1.600	650
44954/245	83,50 kg	900	1.600	650
44954/345	83,50 kg	900	1.600	650
44954/445	83,50 kg	900	1.600	650

2 GAVETAS
CAJONES
DRAWERS

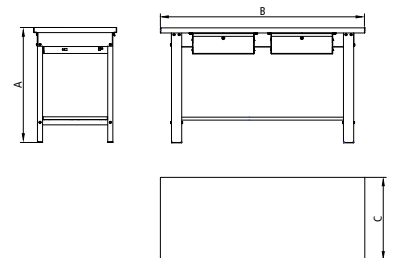

Cores disponíveis
Colores disponibles
Available colors:



Aplicações | Aplicación | Application

- Armazenamento de ferramentas manuais e base de trabalho para manutenção de peças.
- Almacenamiento de herramientas manuales y base de trabajo para mantenimiento de piezas.
- Storage of hand tools and work base for tools maintenance.



REF.	PESO WEIGHT	Medidas Dimensiones Dimensions (mm)				
		A	B	C	D	E
● 44954/060	61,50 kg	750	1.600	650	1.100	25
● 44954/260	61,50 kg	750	1.600	650	1.100	25
● 44954/360	61,50 kg	750	1.600	650	1.100	25
● 44954/460	61,50 kg	750	1.600	650	1.100	25

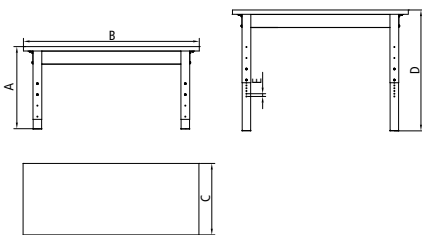

Cores disponíveis
Colores disponibles
Available colors:



Aplicações | Aplicación | Application

- Utilizada como base de trabalho para manutenção de peças.
- Utilizada como base de trabajo para mantenimiento de piezas.
- Used as work base for tools maintenance.

Bancada simples com pernas reguláveis

Bancada sencilla con piernas regulables
Simple workbench with adjustable legs



Tampo de 1,6 m em madeira com espessura de 40 mm.
Estrutura em chapas de aço conformadas.
Altura mínima: 750 mm | Altura máxima: 1.100 mm (passo 25 mm).
Capacidade de carga máxima: 250 kg.
Espessuras das chapas das pernas: 1,2 mm.
Pintura eletrostática.

Tapa de 1,6 m em madera con espesor de 40 mm.
Estructura en chapas de acero conformadas.
Altura mínima: 750 mm |
Altura máxima: 1.100 mm (paso 25 mm).
Capacidad de carga máxima: 250 kg.
Espesor de las chapas: 1,2 mm.
Pintura electrostática.

1.6 m length wood worktop with 40 mm thickness.
Conformed steel sheets structure.
Minimal height: 750 mm |
Maximum height: 1.100 mm (pass 25 mm).
Total load capacity: 250 kg.
Sheet thickness: 1.2 mm.
Electrostatic painting.



Bancada simples com 2 pernas

Bancada sencilla con 2 piernas
Simple workbench with 2 legs



Tampo de 1,6 m em madeira com espessura de 40 mm.
Estrutura em chapas de aço conformadas.
Capacidade de carga máxima: 250 kg.
Espessuras das chapas das pernas: 1,2 mm.
Pintura eletrostática.

Tapa de 1,6 m em madera con espesor de 40 mm.
Estructura en chapas de acero conformadas.
Capacidad total de carga máxima: 250 kg.
Espesor de las chapas: 1,2 mm.
Pintura electrostática.

1.6 m length wood worktop with 40 mm thickness.
Conformed steel sheets structure.
Total load capacity: 250 kg.
Sheet thickness: 1.2 mm.
Electrostatic painting.

REF.	PESO WEIGHT	Medidas Dimensiones Dimensions (mm)		
		A	B	C
● 44954/061	55,00 kg	900	1.600	650
● 44954/261	55,00 kg	900	1.600	650
● 44954/361	55,00 kg	900	1.600	650
● 44954/461	55,00 kg	900	1.600	650

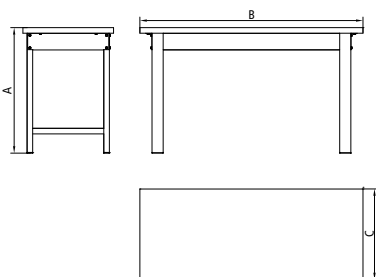

Cores disponíveis
Colores disponibles
Available colors:



Aplicações | Aplicación | Application

- Utilizada como base de trabalho para manutenção de peças.
- Utilizada como base de trabajo para mantenimiento de piezas.
- Used as work base for tools maintenance.

Armário vertical

Armario vertical | Vertical tool cabinet

2

PORTAS
PUERTAS
DOORS

44955/010 /210 /310 /410
Sem visores. | Sin visores. |
Without viewers.



2

PORTAS
PUERTAS
DOORS

44955/020 /220 /320 /420
Com visores. | Con visores. |
With viewers.



Com visor
Con visor
With viewer.



REF.	PESO WEIGHT	Medidas Dimensiones Dimensions (mm)		
		A	B	C
44955/010	113,00 kg	1.830	1.020	550
44955/210	113,00 kg	1.830	1.020	550
44955/310	113,00 kg	1.830	1.020	550
44955/410	113,00 kg	1.830	1.020	550
44955/020	113,00 kg	1.830	1.020	550
44955/220	113,00 kg	1.830	1.020	550
44955/320	113,00 kg	1.830	1.020	550
44955/420	113,00 kg	1.830	1.020	550

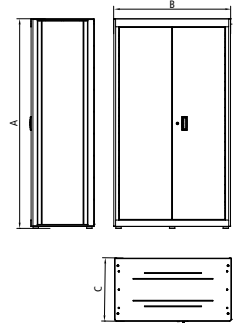

Informações gerais | Informaciones generales | General information:

Estrutura em chapas de aço conformadas.
2 portas com abertura de 100°.
Tranca para a portas.
Capacidade de carga máxima distribuída: 400 kg.
Capacidade de carga distribuída de cada prateleira: 60 kg.
Espessuras das chapas do corpo, porta e prateleiras: 0,9 mm.
Pintura eletrostática.

Cores disponíveis
Colores disponibles
Available colors:



Estructura en chapas de acero conformadas.
2 puertas con apertura de 100°.
Traba para la puertas.
Capacidad de carga máxima repartida: 400 kg.
Capacidad de carga repartida máxima de cada estante: 60 kg.
Espesor de las chapas de la estructura, puerta y estante: 0,9 mm.
Pintura electrostática.

Conformed steel sheets structure.
2 doors with 100° opening.
Lock for the doors.
Maximum distributed load capacity: 400 kg.
Maximum distributed individual rack capacity: 60 kg.
Body, doors and rack sheet thickness: 0.9 mm.
Electrostatic painting.



Pés de regulagem de altura,
para compensar irregularidades
no piso.

Pies de ajuste de altura para
compensar las irregularidades
del suelo.

Adjustable feet for height
adjustment when floors are
irregular.



Tranca para as portas com
chave e puxador de plástico.

Cierre con llave para las
puertas y tirador de plástico.

Doors with key locking
system and plastic handle.



Prateleiras móveis que
possibilitam diferentes
configurações de montagem.

Estantes móveis que permiten
diferentes configuraciones de
montaje.

Mobile racks that enables different
mounting configurations

Aplicações | Aplicación | Application

- Armazenamento de ferramentas manuais.
- Almacenamiento de herramientas manuales.
- Storage of hand tools.



REF.	PESO WEIGHT	Medidas Dimensiones Dimensions (mm)				
		A	B	C	D	E
● 44955/023	140,00 kg	1.830	1.020	550	420	445
● 44955/223	140,00 kg	1.830	1.020	550	420	445
● 44955/323	140,00 kg	1.830	1.020	550	420	445
● 44955/423	140,00 kg	1.830	1.020	550	420	445
● 44955/024	135,00 kg	1.830	1.020	550	420	445
● 44955/224	135,00 kg	1.830	1.020	550	420	445
● 44955/324	135,00 kg	1.830	1.020	550	420	445
● 44955/424	135,00 kg	1.830	1.020	550	420	445

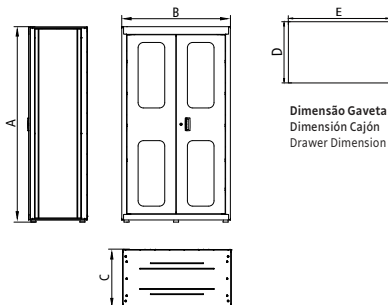

Informações gerais | Informaciones generales | General information:

Estrutura em chapas de aço conformadas.
2 portas com abertura de 100° com visores de acrílico.
Módulo de ferramentas com 5 gavetas com corrediças telescópicas.
Tranca para as portas e gavetas.
Capacidade de carga máxima distribuída: 400 kg.
Capacidade de carga distribuída de cada prateleira: 60 kg.
Espessuras das chapas do corpo, porta e prateleiras: 0,9 mm.
Espessuras das chapas do módulo de ferramentas: 1,2 mm.
Pintura eletrostática.

Cores disponíveis
Colores disponibles
Available colors:



Estrutura em chapas de aço conformadas.
2 portas com abertura de 100° com visores de acrílico.
Módulo para ferramentas com 5 cajones de rieles telescópicos.
Traba para las puertas y cajones.
Capacidad de carga máxima repartida: 400 kg.
Capacidad de carga repartida máxima de cada estante: 60 kg.
Espesor de las chapas de la estructura, puerta y estante: 0,9 mm.
Espesor de las chapas del módulo para herramientas: 1,2 mm.
Pintura electrostática.

Conformed steel sheets structure.
2 doors with 100° opening and acrylic viewers.
Tool modular with 5 ball bearing slides drawers.
Lock for the doors and drawers.
Maximum distributed load capacity: 400 kg.
Maximum distributed individual rack capacity: 60 kg.
Tool cabinet body, doors and rack sheet thickness: 0.9 mm.
Tool modular unit sheet thickness: 1.2 mm.
Electrostatic painting.



Pés de regulagem de altura, para compensar irregularidades no piso. | Pies de ajuste de altura para compensar las irregularidades del suelo. | Adjustable feet for height adjustment when floors are irregular.



Prateleiras móveis que possibilitam diferentes configurações de montagem. | Estantes móviles que permiten diferentes configuraciones de montaje. | Mobile racks that enables different mounting configurations



Corrediças telescópicas que garantem maior abertura da gaveta. | Rieles telescópicos que garantizan mayor apertura del cajón. | Ball bearing slides that assure allow maximum of the drawer opening.



Sistema especial de travamento de gavetas. | Sistema especial de traba de los cajones. | Special system to lock the drawers.



Tranca para as portas com chave e puxador de plástico. | Cierre con llave para las puertas y tirador de plástico. | Doors with key locking system and plastic handle.



Trancas para as gavetas. | Traba para los cajones. | Drawers with key locking system.

Armário com 5 gavetas e visores

Armario con 5 cajones y visores

Tool cabinet with 5 drawers and viewers

2 PORTAS
PUERTAS
DOORS

5 GAVETAS
CAJONES
DRAWERS

44955/023 / 223 / 323 / 423
Com visores. | Con visores. | With viewers.

Com visor
Con visor
With viewer.



2 PORTAS
PUERTAS
DOORS

5 GAVETAS
CAJONES
DRAWERS

44955/024 / 224 / 324 / 424
Com visores. | Con visores. | With viewers.

Com visor
Con visor
With viewer.



44955/024 / 224 / 324 / 424

*Painéis internos perfurados para armazenamento de ferramentas.
*Acompaña 30 ganchos para ferramentas de 65 mm de comprimento.

*Paneles internos perforados para almacenamiento de herramientas.
*Acompaña 30 ganchos para herramientas de 65 mm.

*Perforated internal panels for tool storage.
*Follow with 30 pieces 65 mm tools hooks.

Aplicações | Aplicación | Application

- Armazenamento de ferramentas manuais.
- Almacenamiento de herramientas manuales.
- Storage of hand tools.

Armário vertical

Armario vertical | Vertical tool cabinet



Acompanha 29 caixas plásticas BIN sendo 16 caixas nº3, 9 caixas nº 5 e 4 caixas nº 7 para o armazenamento de peças pequenas, tais como parafusos, porcas, arruelas, etc.

Viene con 29 cubetas BIN siendo 16 cajas nº 3, 9 cajas nº 5 y 4 cajas nº 7, para el almacenamiento de piezas pequeñas como tornillos, tuercas, arandelas, etc.

Comes with 29 plastic BINs: 16 nº 3, 9 nº 5 and 4 nº 7, for the storage of small parts such as bolts, nuts, washers, etc.



REF.	PESO WEIGHT	Medidas Dimensiones Dimensions (mm)		
		A	B	C
● 44955/011	125,00 kg	1.830	570	550
● 44955/211	125,00 kg	1.830	570	550
● 44955/311	125,00 kg	1.830	570	550
● 44955/411	125,00 kg	1.830	570	550
● 44955/012	105,00 kg	1.830	570	550
● 44955/212	105,00 kg	1.830	570	550
● 44955/312	105,00 kg	1.830	570	550
● 44955/412	105,00 kg	1.830	570	550

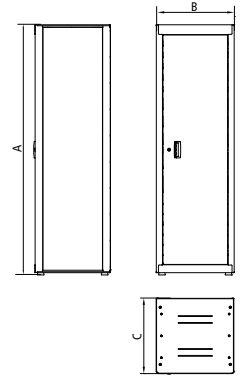

Informações gerais | Informaciones generales | General information:

Estrutura em chapas de aço conformadas.
 Porta com abertura de 100°.
 Tranca para a porta.
 Capacidade de carga máxima distribuída: 200 kg.
 Capacidade de carga distribuída de cada prateleira: 60 kg.
 Espessuras das chapas do corpo, porta e prateleiras: 0,9 mm.
 Pintura eletrostática.

Cores disponíveis
 Colores disponibles
 Available colors:



Estructura en chapas de acero conformadas.
 Puerta con apertura de 100°.
 Traba para la puerta.
 Capacidad de carga máxima repartida: 200 kg.
 Capacidad de carga repartida máxima de cada estante: 60 kg.
 Espesor de las chapas de la estructura, puerta y estante: 0,9 mm.
 Pintura electrostática.

Conformed steel sheets structure.
 Door with 100° opening.
 Lock for the door.
 Maximum distributed load capacity: 200 kg.
 Maximum distributed individual rack capacity: 60 kg.
 Body, doors and rack sheet thickness: 0.9 mm.
 Electrostatic painting.



Pés de regulagem de altura, para compensar irregularidades no piso.

Pies de ajuste de altura para compensar las irregularidades del suelo.

Adjustable feet for height adjustment when floors are irregular.



Tranca para as portas com chave e puxador de plástico.

Cierre con llave para las puertas y tirador de plástico.

Doors with key locking system and plastic handle.



Prateleiras móveis que possibilitam diferentes configurações de montagem.

Estantes móveis que permiten diferentes configuraciones de montaje.

Mobile racks that enables different mounting configurations

Aplicações | Aplicación | Application

- Armazenamento de ferramentas.
- Almacenamiento de herramientas manuales.
- Storage of hand tools.



REF.	PESO WEIGHT	Medidas Dimensiones Dimensions (mm)		
		A	B	C
● 44955/021	125,00 kg	1.830	570	550
● 44955/221	125,00 kg	1.830	570	550
● 44955/321	125,00 kg	1.830	570	550
● 44955/421	125,00 kg	1.830	570	550
● 44955/022	105,00 kg	1.830	570	550
● 44955/222	105,00 kg	1.830	570	550
● 44955/322	105,00 kg	1.830	570	550
● 44955/422	105,00 kg	1.830	570	550

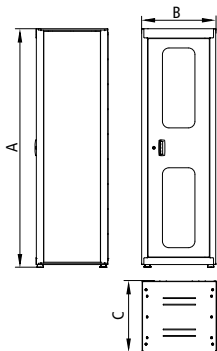

Armário vertical com visor

Armario vertical con visor

Vertical tool cabinet with viewers



Acompaña 29 caixas plásticas BIN sendo 16 caixas nº3, 9 caixas nº 5 e 4 caixas nº 7 para o armazenamento de peças pequenas, tais como parafusos, porcas, arruelas, etc.

Viene con 29 cubetas BIN siendo 16 cajas nº 3, 9 cajas nº 5 y 4 cajas nº 7, para el almacenamiento de piezas pequeñas como tornillos, tuercas, arandelas, etc.

Comes with 29 plastic BINs: 16 nº 3, 9 nº 5 and 4 nº 7, for the storage of small parts such as bolts, nuts, washers, etc.

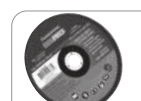

Informações gerais | Informaciones generales | General information:

Estrutura em chapas de aço conformadas.
Porta com abertura de 100° com visores de acrílico.
Tranca para a porta.
Capacidade de carga máxima distribuída: 200 kg.
Capacidade de carga distribuída de cada prateleira: 60 kg.
Espessuras das chapas do corpo, porta e prateleiras: 0,9 mm.
Pintura eletrostática.

Cores disponíveis
Colores disponibles
Available colors:



Estructura en chapas de acero conformadas.
Puerta con apertura de 100° con visor de acrílico.
Traba para la puerta.
Capacidad de carga máxima repartida: 200 kg.
Capacidad de carga repartida máxima de cada estante: 60 kg.
Espesor de las chapas de la estructura, puerta y estante: 0,9 mm.
Pintura electrostática.

Conformed steel sheets structure.
Door with 100° opening and acrylic viewers.
Lock for the door.
Maximum distributed load capacity: 200 kg.
Maximum distributed individual rack capacity: 60 kg.
Body, doors and rack sheet thickness: 0.9 mm.
Electrostatic painting.



Pés de regulagem de altura, para compensar irregularidades no piso.

Pies de ajuste de altura para compensar las irregularidades del suelo.

Adjustable feet for height adjustment when floors are irregular.



Tranca para as portas com chave e puxador de plástico.

Cierre con llave para las puertas y tirador de plástico.

Doors with key locking system and plastic handle.



Prateleiras móveis que possibilitam diferentes configurações de montagem.

Estantes móveis que permiten diferentes configuraciones de montaje.

Mobile racks that enables different mounting configurations



Aplicações | Aplicación | Application

- Armazenamento de ferramentas.
- Almacenamiento de herramientas manuales.
- Storage of hand tools.

MONTE O ARMÁRIO CONFORME A NECESSIDADE

Arme el armario de acuerdo a necesidad |
Assemble the cabinet according to necessity

1º

ESCOLHA O TAMANHO E CONFIGURAÇÃO DAS GAVETAS

ELIJA EL TAMAÑO Y LA CONFIGURACIÓN DE LOS CAJONES / CHOOSE THE SIZE AND CONFIGURATION OF THE DRAWERS



Gavetas mistas |
Cajones mixtos |
Mixed drawers



5 gavetas de 180 mm de largura |
5 cajones de 180 mm de ancho |
5 drawers 180 mm wide



3 gavetas de 310 mm de largura |
3 cajones de 310 mm de ancho |
3 drawers 310 mm wide

2º

ESCOLHA A DISPOSIÇÃO INTERNA DE CADA GAVETA

ELIJA LA DISPOSICIÓN INTERNA DEL CAJÓN / CHOOSE THE DRAWER INTERNAL LAYOUT



7 prateleiras metálicas com
divisórias | 7 niveles de baldas
metálicas con separadores | 7 levels of metal-
lic shelves with partitions



112 caixas organizadoras BIN número 3
| 112 cajas BIN número 3 | 112 BIN boxes
number 3



Chapas perfuradas duplas,
permitindo exposição em ambos os lados |
Paneles perforados dobles,
que permiten la exposición por ambos lados |
Double perforated plates, allowing exposure on both sides

SISTEMA INOVADOR,
COM APROVEITAMENTO DE
ESPAÇO 5 VEZES MAIOR,
SE COMPARADO
AO ARMÁRIO NORMAL.

SISTEMA INNOVADOR,
CON 5 VECES MÁS
CAPACIDAD DE USO DEL ESPACIO,
EN COMPARACIÓN CON
EL ARMARIO NORMAL.

INNOVATIVE SYSTEM,
WITH 5 TIMES MORE SPACE
UTILIZATION, WHEN COMPARED
TO A NORMAL CABINET.



5.120 mm



1.040 mm

REF.	PESO WEIGHT	Medidas Dimensiones Dimensions (mm)		
		A	B	C
● 44967/000	385,00 kg	1.040	1.050	1.840
● 44967/200	385,00 kg	1.040	1.050	1.840
● 44967/300	385,00 kg	1.040	1.050	1.840
● 44967/400	385,00 kg	1.040	1.050	1.840

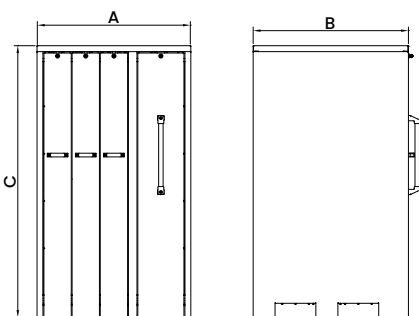

Estrutura robusta produzida em chapas de aço conformadas.
Sistema de gaveteiros verticais rolamentados com rodízios de nylon.
Tranca individuais para todas as gavetas.
Pintura eletrostática a pó.
Capacidade de carga por gaveta: 600 kg
Espessuras das chapas do corpo: 1,9 mm.

Estructura robusta producida en chapas de acero conformadas.
Sistema de cajones verticales con rodamientos y ruedas de nylon.
Cerraduras individuales para todos los cajones.
Pintura electrostática en polvo.
Capacidad de carga por cajón: 600 kg
Espesor de las chapas del cuerpo: 1,9 mm.

Robust structure made in conformed steel sheets.
Bearing rolled vertical drawers system with nylon casters.
Individual locks for all drawers.
Electrostatic powder painting.
Load capacity for drawer: 600 kg.
Body sheets thickness: 1.9 mm.

Aplicações | Aplicación | Application

- Armazenamento de ferramentas manuais, componentes e peças em geral.
- Almacenamiento de herramientas manuales, componentes y piezas en general.
- Storage of hand tools and general pieces.

Cores disponíveis
Colores disponibles
Available colors:



Armário vertical com gaveteiros modulares

Armario vertical con cajones modulares

Vertical cabinet with modular drawers

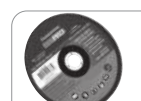

44967/000 - Configuração das gavetas | Configuración de los cajones | Drawers configuration:

Configurado com sistema misto de gavetas.
Duas gavetas com chapas perfuradas. 5 metros quadrados de área para armazenamento e organização de ferramentas.
Uma gaveta com 112 caixas BIN número 3 para armazenamento de peças pequenas.
Uma gaveta com 7 níveis de prateleiras metálicas com divisórias.
Capacidade de carga máxima distribuída: 2.400 kg.
Acompanha 60 ganchos para ferramentas de 65 mm de comprimento e 112 caixas tipo BIN número 3.

Configurado con sistema de cajones mixtos.
Dos cajones con paneles perforados. 5 metros cuadrados de área para almacenamiento y organización de herramientas.
Un cajón con 112 cajas BIN número 3 para almacenamiento de piezas pequeñas.
Un cajón con 7 niveles de baldas metálicas con separadores.
Capacidad máxima de carga distribuida: 2.400 kg.
Acompaña 60 ganchos para herramientas de 65 mm de largo y 112 cajas BIN número 3.

Configured with mixed drawers system.
Two drawers with punched sheets. 5 square meters of area for storage and tools organization.
One drawer with 112 BIN boxes number 3 for storage of small pieces.
One drawer with 7 levels of metallic shelves with partitions.
Maximum distributed load capacity: 2,400 kg.
60 hooks for 65 mm long tools and 112 BIN boxes number 3 included.

Contato para projetos especiais | Contacto para proyectos especiales | Contact for special projects: modulares.gar@tramontina.com

Estrutura armário para gaveteiros verticais

Estructura de armário para cajones verticales
Cabinet structure for vertical drawers

REF.	PESO WEIGHT
● 44967/001	176,00 kg
● 44967/201	176,00 kg
● 44967/301	176,00 kg
● 44967/401	176,00 kg

**Gaveta 180 mm de largura com chapas perfuradas para organização de ferramentas em ambos os lados**

| Cajón de 180 mm de ancho con placas perforadas para organizar herramientas en ambos lados | 180 mm width drawer with punched sheets for both sides tools storage

REF.	PESO WEIGHT
44967/903	93,50 kg

**Gaveta 310 mm de largura com chapas perfuradas para organização de ferramentas em ambos os lados**

| Cajón de 310 mm de ancho con chapas perforadas para ordenar herramientas en ambos los lados | 310 mm width drawer with punched sheets for both sides tools storage

REF.	PESO WEIGHT
44967/901	93,50 kg

**Gaveta 180 mm de largura com 7 níveis de prateleiras metálicas com divisórias**

| Cajón de 180 mm de ancho con 7 niveles de estanterías metálicas con separadores | 180 mm width drawer with 7 levels of metallic shelves with partitions

REF.	PESO WEIGHT
44967/904	93,50 kg

**Gaveta 310 mm de largura com 7 níveis de prateleiras metálicas com divisórias**

| Cajón de 310 mm de ancho con 7 niveles de estanterías metálicas con separadores | 310 mm width drawer with 7 levels of metallic shelves with partitions

REF.	PESO WEIGHT
44967/902	93,50 kg

**Gaveta 180 mm de largura com 7 níveis e 112 caixas BIN nº 3**

| Cajón de 180 mm de ancho con 7 niveles y 112 cajas BIN nº 3 | 180 mm width drawer with 7 levels and 112 BIN boxes number 3

REF.	PESO WEIGHT
44967/905	93,50 kg



REF.	PESO WEIGHT	Medidas Dimensiones Dimensions (mm)		
		A	B	C
● 44956/001	49,50 kg	1.830	770	550
● 44956/201	49,50 kg	1.830	770	550
● 44956/301	49,50 kg	1.830	770	550
● 44956/401	49,50 kg	1.830	770	550
● 44956/002	59,50 kg	1.830	1.000	550
● 44956/202	59,50 kg	1.830	1.000	550
● 44956/302	59,50 kg	1.830	1.000	550
● 44956/402	59,50 kg	1.830	1.000	550

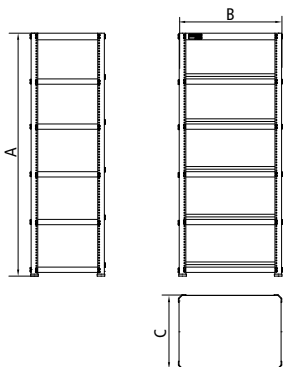

Estrutura em chapas de aço conformadas de 1,2 mm de espessura.
Capacidade de carga máxima distribuída: 400 kg.
Capacidade de carga distribuída de cada prateleira: 60 kg.
Pintura eletrostática.

Estructura en chapas de acero conformadas con espesor de 1,2 mm.
Capacidad de carga máxima repartida: 400 kg.
Capacidad de carga repartida máxima de cada estante: 60 kg.
Pintura electrostática.

Conformed steel sheets structure with 1.2 mm thickness.
Maximum distributed load capacity: 400 kg.
Maximum distributed individual rack capacity: 60 kg.
Electrostatic painting.

Cores disponíveis
Colores disponibles
Available colors:



Estante metálica

Estantería metálica | Steel shelving

6 PRATELEIRAS
ESTANTES
SHELVES



Aplicações | Aplicación | Application

- Armazenamento de ferramentas manuais, componentes e peças em geral.
- Almacenamiento de herramientas manuales, componentes y piezas en general.
- Storage of hand tools and general pieces.

Módulos de parafusos

Caja plástica BIN | BIN plastic box



Corpo injetado em plástico.
Cuerpo inyectado en plástico.
Plastic injected body.

Aplicações | Aplicación | Application

- Utilizadas para o armazenamento de peças pequenas, tais como parafusos, porcas, arruelas, etc.
- Utilizada para el almacenamiento de piezas pequeñas como tornillos, tuercas, arandelas, etc.
- Used for the storage of small parts such as bolts, nuts, washers, etc.

REF.	PESO WEIGHT	Medidas Dimensiones Dimensions (mm)		
		A	B	C
44955/901	170 g	75	180	105
44955/902	410 g	120	250	155
44955/903	840 g	230	580	390

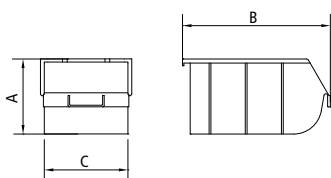

REF.	NR.	CAPACIDADE CAPACIDAD CAPACITY LITROS LITROS LITERS
44955/901	3	1
44955/902	5	4
44955/903	7	13

Panel superior

Panel superior | Wall tool panel

2

PORTAS
PUERTAS
DOORS

44953/004 /204 /304 /404
Painel pequeno.
Panel pequeño.
Small panel.



REF.	PESO WEIGHT	Medidas Dimensiones Dimensions (mm)		
		A	B	C
● 44953/004	28,50 kg	620	794	300
● 44953/204	28,50 kg	620	794	300
● 44953/304	28,50 kg	620	794	300
● 44953/404	28,50 kg	620	794	300
● 44953/005	41,50 kg	930	794	300
● 44953/205	41,50 kg	930	794	300
● 44953/305	41,50 kg	930	794	300
● 44953/405	41,50 kg	930	794	300

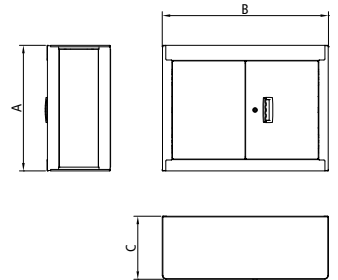

Informações gerais | Informaciones generales | General information:

Cores disponíveis
Colores disponibles
Available colors:



Estrutura em chapas de aço conformadas.
Duas portas com abertura de 100°.
Trancas para as portas.
Capacidade de carga máxima distribuída: 150 kg.
Capacidade de carga distribuída da prateleira: 60 kg.
Espessuras das chapas do corpo, porta e prateleiras: 0,9 mm.
Pintura eletrostática.

Estructura en chapas de acero conformadas.
Dos puertas con apertura de 100°.
Traba para las puertas.
Capacidad de carga máxima repartida: 150 kg.
Capacidad de carga repartida máxima de la estante: 60 kg.
Espesor de las chapas de la estructura, puerta y estante: 0,9 mm.
Pintura electrostática.

Conformed steel sheets structure.
Two doors with 100° opening.
Lock for the doors.
Maximum distributed load capacity: 150 kg.
Maximum distributed rack capacity: 60 kg.
Body, doors and rack sheet thickness: 0.9 mm.
Electrostatic painting.

2

PORTAS
PUERTAS
DOORS

44953/005 /205 /305 /405
Painel grande.
Panel grande.
Large panel.



Possui furos na parte traseira para fixação na parede através de parafusos.

Tiene agujeros en la parte posterior para fijación en la pared con tornillos.

It has holes on the back side for easy wall fixation with screws.



Tranca para as portas com chave e puxador de plástico.

Cierre con llave para las puertas y tirador de plástico.

Doors with key locking system and plastic handle.



Prateleiras móveis que possibilitam diferentes configurações de montagem.

Estantes móviles que permiten diferentes configuraciones de montaje.

Mobile racks that enables different mounting configurations

Aplicações | Aplicación | Application

- Armazenamento de ferramentas manuais, componentes e peças em geral.
- Almacenamiento de herramientas manuales, componentes y piezas en general.
- Storage of hand tools and general pieces.



Painel canto em L com chanfro frontal

Panel esquina L | L corner wall tool panel

REF.	PESO WEIGHT	Medidas Dimensiones Dimensions (mm)		
		A	B	C
● 44953/006	40,00 kg	620	956	300
● 44953/206	40,00 kg	620	956	300
● 44953/306	40,00 kg	620	956	300
● 44953/406	40,00 kg	620	956	300
● 44953/007	57,50 kg	930	956	300
● 44953/207	57,50 kg	930	956	300
● 44953/307	57,50 kg	930	956	300
● 44953/407	57,50 kg	930	956	300

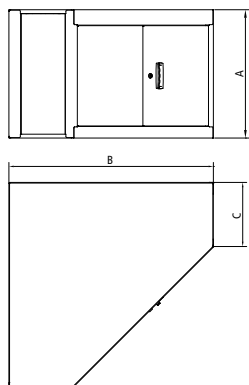

Informações gerais | Informaciones generales | General information:

Estrutura em chapas de aço conformadas.
Duas portas com abertura de 100°.
Trancas para as portas.
Capacidade de carga máxima distribuída: 150 kg.
Capacidade de carga distribuída da prateleira: 60 kg.
Espessuras das chapas do corpo, porta e prateleiras: 0,9 mm.
Pintura eletrostática.

Estructura en chapas de acero conformadas.
Dos puertas con apertura de 100°.
Traba para las puertas.
Capacidad de carga máxima repartida: 150 kg.
Capacidad de carga repartida máxima de la estante: 60 kg.
Espesor de las chapas de la estructura, puerta y estante: 0,9 mm.
Pintura electrostática.

Conformed steel sheets structure.
Two doors with 100° opening.
Lock for the doors.
Maximum distributed load capacity: 150 kg.
Maximum distributed rack capacity: 60 kg.
Body, doors and rack sheet thickness: 0.9 mm.
Electrostatic painting.

Cores disponíveis
Colores disponibles
Available colors:



Aplicações | Aplicación | Application

- Armazenamento de ferramentas manuais, componentes e peças em geral.
- Específico para montagens em cantos com ângulo de 90°.
- Almacenamiento de herramientas manuales, componentes y piezas en general.
- Específico para montaje en esquinas con ángulo de 90°.
- Storage of hand tools and general pieces.
- Specific for assemblies in corners with 90° angle.



Possui furos na parte traseira para fixação na parede através de parafusos.

Tiene agujeros en la parte posterior para fijación en la pared con tornillos.

It has holes on the back side for easy wall fixation with screws.



Tranca para as portas com chave e puxador de plástico.

Cierre con llave para las puertas y tirador de plástico.

Doors with key locking system and plastic handle.

Painel para ferramentas com persianas horizontais de PVC

Panel para herramientas con persianas horizontal de PVC
PVC horizontal rolling shutter tool panel



REF.	PESO WEIGHT	Medidas Dimensiones Dimensions (mm)		
		A	B	C
44953/008	62,00 kg	620	1.600	300
44953/208	62,00 kg	620	1.600	300
44953/308	62,00 kg	620	1.600	300
44953/408	62,00 kg	620	1.600	300

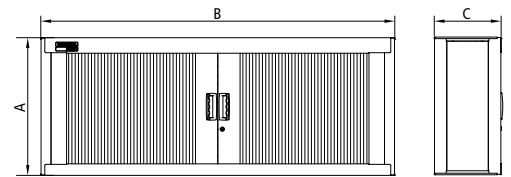

Informações gerais | Informaciones generales | General information:

Estrutura em chapas de aço conformadas.
Duas portas com persianas horizontais de PVC.
Trancas para as portas.
Pintura eletrostática.
Capacidade de carga máxima distribuída: 150 kg.
Espessuras das chapas: 0,9 mm.
Acompanha 30 ganchos para ferramentas de 40 mm de comprimento e 30 ganchos para ferramentas de 65 mm de comprimento.

Estructura en chapas de acero conformadas.
2 puertas con persianas horizontal de PVC.
Traba para las puertas.
Pintura electrostática.
Capacidad de carga máxima repartida: 150 kg.
Espesor de las chapas: 0,9 mm.
Acompaña 30 ganchos para herramientas de 40 mm e 30 ganchos para herramientas de 65 mm.

Conformed steel sheets structure.
2 horizontal rolling shutter PVC doors.
Lock for the doors.
Electrostatic painting.
Maximum distributed load capacity: 150 kg.
Structure sheet thickness: 0.9 mm.
Follow with 30 pieces 40 mm tools hooks and 30 pieces 65 mm tools hooks.

Cores disponíveis
Colores disponibles
Available colors:



Possui furos na parte traseira para fixação na parede através de parafusos.

Tiene agujeros en la parte posterior para fijación en la pared con tornillos.

It has holes on the back side for easy wall fixation with screws.



Tranca para as portas com chave e puxador de plástico.

Cierre con llave para las puertas y tirador de plástico.

Doors with key locking system and plastic handle.

Aplicações | Aplicación | Application

- Armazenamento de ferramentas manuais, componentes e peças em geral.
- Almacenamiento de herramientas manuales, componentes y piezas en general.
- Storage of hand tools and general pieces.



REF.	PESO WEIGHT	Medidas Dimensiones Dimensions (mm)		
		A	B	C
● 44953/011	35,00 kg	930	300	794
● 44953/211	35,00 kg	930	300	794
● 44953/311	35,00 kg	930	300	794
● 44953/411	35,00 kg	930	300	794

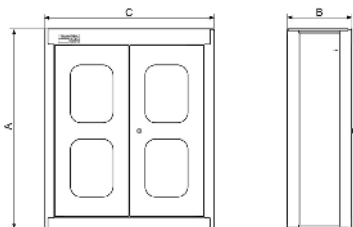

Painel superior para ferramentas

Panel superior para herramientas | Large wall tool panel



Informações gerais | Informaciones generales | General information:

Estrutura em chapas de aço conformadas.
Duas portas com abertura de 100°.
Trancas para as portas com chave.
Painel perfurado interno para armazenamento de ferramentas.
Pintura eletrostática.
Capacidade de carga máxima distribuída: 150 kg.
Espessura das chapas: 0,9 mm.
Acompanha 30 ganchos para ferramentas de 65 mm de comprimento.

Cores disponíveis
Colores disponibles
Available colors:



Possui furos na parte traseira para fixação na parede através de parafusos.

Tiene agujeros en la parte posterior para fijación en la pared con tornillos.

It has holes on the back side for easy wall fixation with screws.



Tranca para as portas com chave e puxador de plástico.

Cierre con llave para las puertas y tirador de plástico.

Doors with key locking system and plastic handle.

Estructura en chapas de acero conformadas.
Dos puertas con apertura de 100°.
Traba para las puertas con llave.
Agujeros internos para almacenamiento de herramientas.
Pintura electrostática.
Capacidad de carga máxima: 150 kg.
Espesor de las chapas: 0,9 mm.
Acompaña 30 ganchos para herramientas de 65 mm.

Conformed steel sheets structure.
Two doors with 100° opening.
Locks for the doors with key.
Internal pegboards to tools storage.
Electrostatic painting.
Maximum load capacity: 150 kg.
Structure sheet thickness: 0.9 mm.
Follow with 30 pieces 65 mm tools hooks.

Aplicações | Aplicación | Application

- Armazenamento de ferramentas manuais, componentes e peças em geral.
- Almacenamiento de herramientas manuales, componentes y piezas en general.
- Storage of hand tools and general pieces.

Painel superior com porta basculante com amortecimento a gás

Panel para herramientas con puerta abatible con amortiguación de gas
Tool panel with tilting door with gas absorber



REF.	PESO WEIGHT	Medidas Dimensiones Dimensions (mm)		
		A	B	C
44953/012	13,60 kg	794	400	300
44953/212	13,60 kg	794	400	300
44953/312	13,60 kg	794	400	300
44953/412	13,60 kg	794	400	300

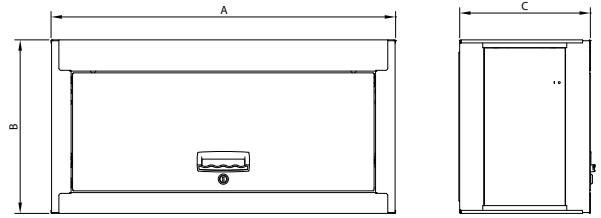

Informações gerais | Informaciones generales | General information:

Estrutura em chapas de aço conformadas.
Porta com abertura para cima.
Tranca para a porta com chave.
Pintura eletrostática.
Capacidade de carga máxima distribuída: 150 kg.
Espessura das chapas: 0,9 mm.

Estructura en chapas de acero conformadas.
Puerta abertura para cima.
Traba para la puerta con llave.
Pintura electrostática.
Capacidad de carga máxima: 150 kg.
Espesor de las chapas: 0,9 mm.

Conformed steel sheets structure.
Upper opening door.
Locks for the doors with key.
Electrostatic painting.
Maximum load capacity: 150 kg.
Structure sheet thickness: 0.9 mm.

Cores disponíveis
Colores disponibles
Available colors:



Possui furos na parte traseira para fixação na parede através de parafusos.

Tiene agujeros en la parte posterior para fijación en la pared con tornillos.

It has holes on the back side for easy wall fixation with screws.



Tranca para as portas com chave e puxador de plástico.

Cierre con llave para las puertas y tirador de plástico.

Doors with key locking system and plastic handle.

Aplicações | Aplicación | Application

- Armazenamento de ferramentas manuais, componentes e peças em geral.
- Almacenamiento de herramientas manuales, componentes y piezas en general.
- Storage of hand tools and general pieces.



REF.	PESO WEIGHT	Medidas Dimensiones Dimensions (mm)		
		A	B	C
● 44953/016	50,00 kg	1.600	930	230
● 44953/216	50,00 kg	1.600	930	230
● 44953/316	50,00 kg	1.600	930	230
● 44953/416	50,00 kg	1.600	930	230

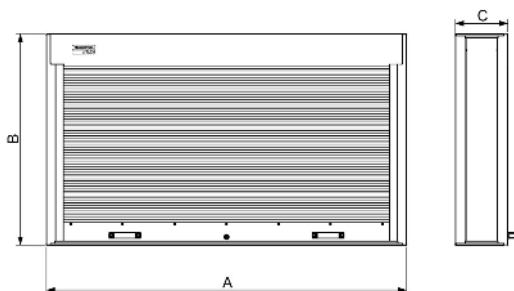

Estrutura em chapas de aço conformadas.
 Porta com persiana de PVC, abertura para cima.
 Tranca para a porta com chave.
 Pintura eletrostática.
 Capacidade de carga máxima distribuída: 150 kg.
 Espessura das chapas: 0,9 mm.
 Acompanha 30 ganchos para ferramentas de 65 mm de comprimento

Estructura en chapas de acero conformadas.
 Puerta con persianas de PVC, abertura para cima.
 Traba para la puerta con llave.
 Pintura electrostática.
 Capacidad de carga máxima: 150 kg.
 Espesor de las chapas: 0,9 mm.
 Acompaña 30 ganchos para herramientas de 65 mm.

Conformed steel sheets structure.
 Upper opening rolling shutter PVC door.
 Locks for the doors with key.
 Electrostatic painting.
 Maximum load capacity: 150 kg.
 Structure sheet thickness: 0.9 mm.
 Follow with 30 pieces 65 mm tools hooks.



Possui furos na parte traseira para fixação na parede através de parafusos.

Tiene agujeros en la parte posterior para fijación en la pared con tornillos.

It has holes on the back side for easy wall fixation with screws.



Tranca para as portas com chave e puxador de plástico.

Cierre con llave para las puertas y tirador de plástico.

Doors with key locking system and plastic handle.

Aplicações | Aplicación | Application

- Armazenamento de ferramentas manuais, componentes e peças em geral.
- Almacenamiento de herramientas manuales, componentes y piezas en general.
- Storage of hand tools and general pieces.

Painel para ferramentas com persiana vertical

Panel para herramientas con persiana vertical

Vertical rolling shutter tool panel



Cores disponíveis
 Colores disponibles
 Available colors:



Painel perfurado para ferramentas

Panel porta herramientas | Punched panel
160 furos | 160 agujeros | 160 holes

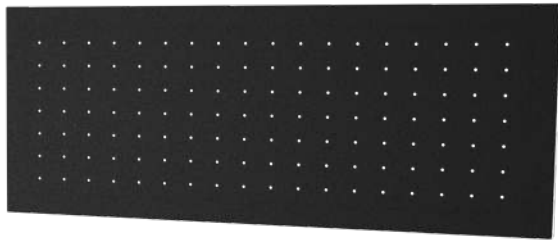

REF.	PESO WEIGHT	Medidas Dimensiones Dimensions (mm)		
		A	B	C
44953/009	2,80 kg	22	799	309

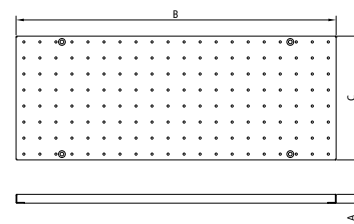

Estrutura em chapas de aço conformadas.
Espessuras das chapas do corpo, portas e prateleiras: 1,06 mm.
Ganchos não inclusos.
Pintura eletrostática.

Estructura en chapas de acero conformadas.
Espesor de las chapas de la estructura, puertas y estante: 1,06 mm.
Ganchos no incluidos.
Pintura electrostática.

Conformed steel sheets structure.
Body, doors and rack sheet thickness: 1.06 mm.
Hooks set not included.
Electrostatic painting.

Aplicações | Aplicación | Application

- Armazenamento de ferramentas manuais, componentes e peças em geral.
- Almacenamiento de herramientas manuales, componentes y piezas en general.
- Storage of hand tools and general pieces.

Painel perfurado de canto para ferramentas

Panel porta herramientas de canto | L corner wall tools
punched panel

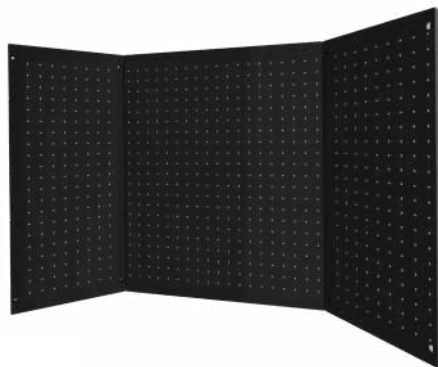

* Forma de uso | Forma de uso | Mode of use

REF.	PESO WEIGHT	Medidas Dimensiones Dimensions (mm)			
		A	B	C	D
44953/013	18,00 kg	960	930	400	755

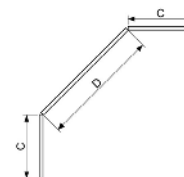
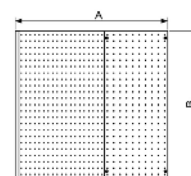

Estrutura em chapas de aço conformadas.
Espessuras das chapas do corpo, portas e prateleiras: 1,20 mm.
Ganchos não inclusos.
Pintura eletrostática.

Estructura en chapas de acero conformadas.
Espesor de las chapas de la estructura, puertas y estante: 1,20 mm.
Ganchos no incluidos.
Pintura electrostática.

Conformed steel sheets structure.
Body, doors and rack sheet thickness: 1.20 mm.
Hooks set not included.
Electrostatic painting.

Aplicações | Aplicación | Application

- Armazenamento de ferramentas manuais, componentes e peças em geral.
- Almacenamiento de herramientas manuales, componentes y piezas en general.
- Storage of hand tools and general pieces.

REF.	TAMANHO TAMANO SIZE	Medidas Dimensiones Dimensions (mm)		
		A	B	C
44953/992	65 mm	65	44	4

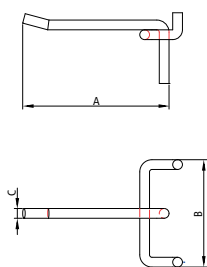

Aplicações | Aplicación | Application

- Utilizado para organização de ferramentas manuais.
- Específicos para painel perfurado Tramontina PRO.
- Utilizado para organizar herramientas manuales.
- Especifico para los paneles perforados Tramontina PRO.
- Used for organizing hand tools.
- Specific for Tramontina PRO punched panel.

REF.	PESO WEIGHT	Medidas Dimensiones Dimensions (mm)		
		A	B	C
44953/993	10 g	180	36	30

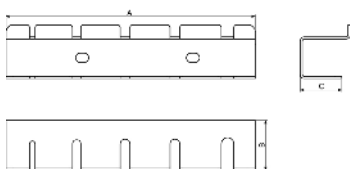

Aplicações | Aplicación | Application

- Utilizado para organização de ferramentas manuais.
- Específicos para painel perfurado Tramontina PRO.
- Utilizado para organizar herramientas manuales.
- Especifico para los paneles perforados Tramontina PRO.
- Used for organizing hand tools.
- Specific for Tramontina PRO punched panel.

REF.	PESO WEIGHT	Medidas Dimensiones Dimensions (mm)		
		A	B	C
44953/994	13 g	120	59	28

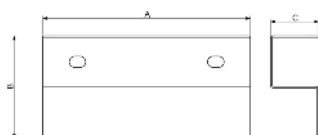

Aplicações | Aplicación | Application

- Utilizado para organização de ferramentas manuais.
- Específicos para painel perfurado Tramontina PRO.
- Utilizado para organizar herramientas manuales.
- Especifico para los paneles perforados Tramontina PRO.
- Used for organizing hand tools.
- Specific for Tramontina PRO punched panel.

Kit ganchos para painel perfurado

Kit ganchos para painel perfurado | Hook set for punched panel



Produzidos em arame de aço dobrado e soldado.
Espaçamento entre encaixes de 40 mm.
Kit com 30 peças.

Producidos en alambre de acero doblado y soldado.
Espaciamento entre las conexiones de 40 mm.
Kit con 30 piezas.

Produced in stamped and soldering steel.
Spacing between the fits of 40 mm.
Set with 30 pieces.

Suporte para chaves de fenda

Soporte de destornilladores para panel perfurado
Pegboard screwdriver holder

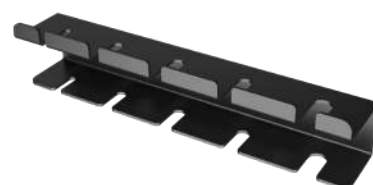

Produzido em chapas de aço conformadas.
Espessura das chapas: 0,9 mm
Acompanha 2 parafusos M6 com encaixe fenda cruzada.
Acomoda até 5 chaves de fenda.
Pintura eletrostática na cor preta.

Producido con chapas de acero conformadas.
Espesor de las chapas: 0,9 mm
Viene con 2 tornillos M6 con cabeza en cruz.
Acomoda hasta 5 destornilladores.
Pintura electrostática negra.

Made of formed steel sheets.
Sheet thickness: 0,9 mm
Comes with 2 M6 cruciform screws.
Holds up to 5 screwdrivers.
Black powder coating.

Suporte de chaves hexagonais para painel perfurado

Soporte de llaves hexagonales para panel perfurado
Pegboard hex key holder



Produzido em chapas de aço conformadas.
Espessura das chapas: 0,9 mm
Acompanha 2 parafusos M6 com encaixe fenda cruzada.
Acomoda até 9 chaves hexagonais.
Pintura eletrostática na cor preta.

Producido con chapas de acero conformadas.
Espesor de las chapas: 0,9 mm
Viene con 2 tornillos M6 con cabeza en cruz.
Acomoda hasta 9 llaves hexagonales.
Pintura electrostática negra.

Made of formed steel sheets.
Sheet thickness: 0,9 mm
Comes with 2 M6 cruciform screws.
Holds up to 5 screwdrivers.
Black powder coating.

Suporte de chaves combinadas para painel perfurado

Suporte de llaves combinadas para panel perforado
Pegboard wrench set holder



Produzido em chapas de aço conformadas.
Espessura das chapas: 0,9 mm
Acompanha 3 parafusos M6 com encaixe fenda cruzada.
Acomoda até 12 chaves combinadas.
Pintura eletrostática na cor preta.

Producido con chapas de acero conformadas.
Espesor de las chapas: 0,9 mm
Viene con 3 tornillos M6 con cabeza en cruz.
Acomoda hasta 12 llaves combinadas.
Pintura electrostática negra.

Made of formed steel sheets.
Sheet thickness: 0.9 mm
Comes with 3 M6 cruciform screws.
Holds a 12-piece wrench set.
Black powder coating.

REF.	PESO WEIGHT	Medidas Dimensiones Dimensions (mm)		
		A	B	C
44953/995	16 g	450	25	38

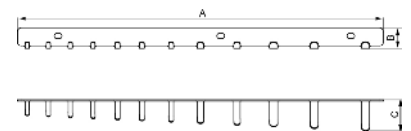

Aplicações | Aplicación | Application

- Utilizado para organização de ferramentas manuais.
- Específicos para painel perfurado Tramontina PRO.
- Utilizado para organizar herramientas manuales.
- Especifico para los paneles perforados Tramontina PRO.
- Used for organizing hand tools.
- Specific for Tramontina PRO punched panel.

Suporte de soquetes e acessórios para painel perfurado

Suporte de dados y accesorios para panel perforado
Pegboard socket and accessories holder



Produzido em chapas de aço conformadas.
Espessura das chapas: 0,9 mm
Acompanha 6 parafusos M6 com encaixe fenda cruzada.
Acomoda até 23 itens.
Pintura eletrostática na cor preta.

Producido con chapas de acero conformadas.
Espesor de las chapas: 0,9 mm
Viene con 6 tornillos M6 con cabeza en cruz.
Acomoda hasta 23 artículos.
Pintura electrostática negra.

Made of formed steel sheets.
Sheet thickness: 0.9 mm
Comes with 6 M6 cruciform screws.
Holds up to 23 pieces.
Black powder coating.

REF.	PESO WEIGHT	Medidas Dimensiones Dimensions (mm)						
		A	B	C	D	E	F	G
44953/996	1,10 kg	210	25	48	325	30	40	58

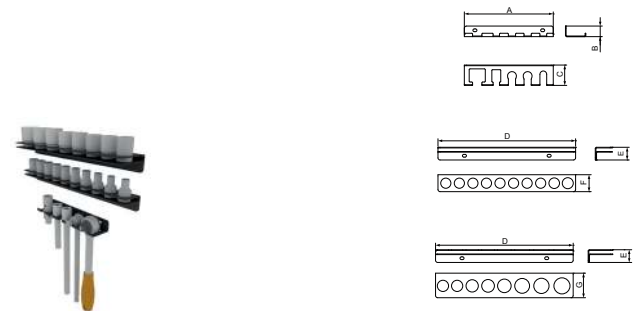

Aplicações | Aplicación | Application

- Utilizado para organização de ferramentas manuais.
- Específicos para painel perfurado Tramontina PRO.
- Utilizado para organizar herramientas manuales.
- Especifico para los paneles perforados Tramontina PRO.
- Used for organizing hand tools.
- Specific for Tramontina PRO punched panel.

Suporte de chaves bielas para painel perfurado

Suporte de llaves pipa para panel perforado
Pegboard hollow offset socket wrench holder

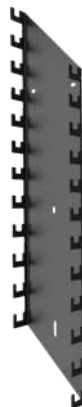

Produzido em chapas de aço conformadas.
Espessura das chapas: 0,9 mm
Acompanha 3 parafusos M6 com encaixe fenda cruzada.
Acomoda até 12 chaves biela.
Pintura eletrostática na cor preta.

Producido con chapas de acero conformadas.
Espesor de las chapas: 0,9 mm
Viene con 3 tornillos M6 con cabeza en cruz.
Acomoda hasta 12 llaves.
Pintura electrostática negra.

Made of formed steel sheets.
Sheet thickness: 0.9 mm
Comes with 3 M6 cruciform screws.
Holds up to 12 socket wrenches.
Black powder coating.

REF.	PESO WEIGHT	Medidas Dimensiones Dimensions (mm)		
		A	B	C
44953/997	97 g	530	115	38



Aplicações | Aplicación | Application

- Utilizado para organização de ferramentas manuais.
- Específicos para painel perfurado Tramontina PRO.
- Utilizado para organizar herramientas manuales.
- Especifico para los paneles perforados Tramontina PRO.
- Used for organizing hand tools.
- Specific for Tramontina PRO punched panel.



REF.	PESO WEIGHT	Medidas Dimensiones Dimensions (mm)		
		A	B	C
44953/998	7 g	60	50	48

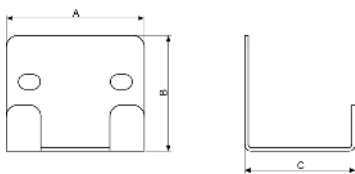

Produzido em chapas de aço conformadas.
Espessura das chapas: 0,9 mm
Acompanha 2 parafusos M6 com encaixe fenda cruzada.
Pintura eletrostática na cor preta.

Producido con chapas de acero conformadas.
Espesor de las chapas: 0,9 mm
Viene con 2 tornillos M6 con cabeza en cruz.
Pintura electrostática negra.

Made of formed steel sheets.
Sheet thickness: 0.9 mm
Comes with 2 M6 cruciform screws.
Black powder coating.

Suporte de martelos e chaves cabo T para painel perfurado
Soporte de martillos y llaves con mango T para panel perforado
Hammer and T-handle wrench holder for pegboard

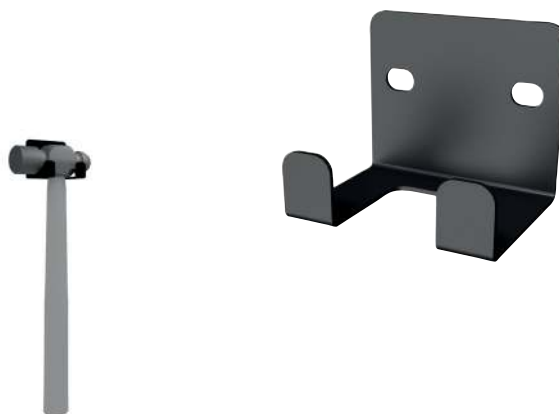

Aplicações | Aplicación | Application

- Utilizado para organização de ferramentas manuais.
- Específicos para painel perfurado Tramontina PRO.
- Utilizado para organizar herramientas manuales.
- Especifico para los paneles perforados Tramontina PRO
- Used for organizing hand tools.
- Specific for Tramontina PRO punched panel.

REF.	PESO WEIGHT	Medidas Dimensiones Dimensions (mm)		
		A	B	C
44953/999	1,10 kg	450	65	80

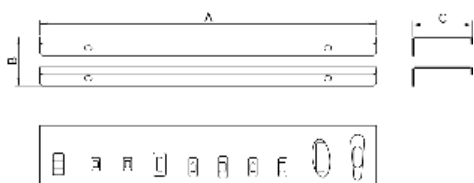

Produzido em chapas de aço conformadas.
Espessura das chapas: 0,9 mm
Acompanha 4 parafusos M6 com encaixe fenda cruzada.
Acomoda até 10 alicates.
Pintura eletrostática na cor preta.

Producido con chapas de acero conformadas.
Espesor de las chapas: 0,9 mm
Viene con 4 tornillos M6 con cabeza en cruz.
Acomoda hasta 10 pinzas.
Pintura electrostática negra.

Made of formed steel sheets.
Sheet thickness: 0.9 mm
Comes with 4 M6 cruciform screws.
Holds up to 10 pliers.
Black powder coating.

Suporte de alicates para painel perfurado
Soporte de pinzas para panel perforado
Pegboard pliers holder



Aplicações | Aplicación | Application

- Utilizado para organização de ferramentas manuais.
- Específicos para painel perfurado Tramontina PRO.
- Utilizado para organizar herramientas manuales.
- Especifico para los paneles perforados Tramontina PRO
- Used for organizing hand tools.
- Specific for Tramontina PRO punched panel.



Carro para ferramentas

Carro para ferramentas | Tool cabinet

Advantage
Gavetas



Gavetas com 75 mm de altura.
Duas portas na parte inferior do carro.
Trancas para as gavetas e portas.

Cajones de 75 mm de altura.
Dos puertas en la parte inferior del carro.
Trabas para los cajones y puertas.

Drawers 75 mm high.
Two doors in lower part of tool cabinet.
Locking system with key for drawers and door.



Três gavetas com 75 mm de altura.
Duas gavetas com 155 mm de altura.
Tranca para as gavetas.

Tres cajones de 75 mm de altura.
Dos cajones de 155 mm de altura.
Traba para los cajones.

Three drawers 75 mm high.
Two drawers 155 mm high.
Locking system with key for drawers.



Cinco gavetas com 75 mm de altura.
Uma gaveta com 155 mm de altura.
Trancas para as gavetas.

Cinco cajones de 75 mm de altura.
Un cajón de 155 mm de altura.
Traba para los cajones.

Five drawers 75 mm high.
One drawer 155 mm high.
Locking system with key for drawers.

REF.	PESO WEIGHT	Medidas Dimensiones Dimensions (mm)				
		A	B	C	D	E
44950/006	36,65 kg	851	650	460	420	445
44950/206	36,65 kg	851	650	460	420	445
44950/306	36,65 kg	851	650	460	420	445
44950/406	36,65 kg	851	650	460	420	445
44950/007	46,80 kg	851	650	460	420	445
44950/207	46,80 kg	851	650	460	420	445
44950/307	46,80 kg	851	650	460	420	445
44950/407	46,80 kg	851	650	460	420	445
44950/010	53,00 kg	851	650	460	420	445
44950/210	53,00 kg	851	650	460	420	445
44950/310	53,00 kg	851	650	460	420	445
44950/410	53,00 kg	851	650	460	420	445

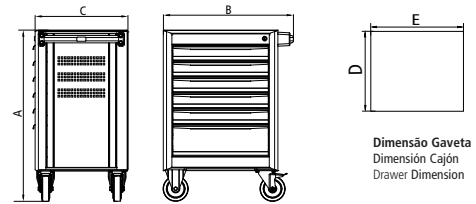

Informações gerais | Informaciones generales | General information:

Cores disponíveis
Colores disponibles
Available colors:



Estrutura com paredes reforçadas.
Gavetas com corrediças telescópicas.
Rodas dianteiras fixas de borracha com 125 mm de diâmetro.
Rodas traseiras giratórias de borracha com 125 mm de diâmetro.
Rodas traseiras providas de freio individual.
Capacidade de carga máxima por gaveta: com altura de 75 mm: 20 kg |
com altura de 155 mm: 30 kg.
Capacidade estática: 300 kg. | Capacidade dinâmica: 200-250 kg.
Espessuras das chapas: corpo e gavetas: 1,2 mm.
Acompanha puxador ergonômico e lâmina de borracha para tampo superior.
Pintura eletrostática.

Estructura con paredes reforzadas.
Cajones con rieles telescópicos.
Ruedas delanteras fijas de goma de 125 mm de diámetro.
Ruedas traseras giratorias de goma de 125 mm de diámetro.
Ruedas traseras con freno individual.
Capacidad de carga máxima por cajón: con altura de 75 mm: 20 kg |
con altura de 155 mm: 30 kg.
Capacidad estática: 300 kg | Capacidad dinámica: 200-250 kg.
Espesor de las chapas: estructura y cajones: 1,2 mm.
Tirador ergonómico y revestido de goma.
Pintura electrostática.

Body with reinforced structure.
Drawers with ball bearing slides.
Rubber fixed front wheels with diameter of 125 mm.
Rubber swivel rear wheels with diameter of 125 mm.
Rear wheels equipped with brake.
Drawer capacity: 75 mm high: 20 kg | 155 mm high: 30 kg.
Static capacity: 300 kg | Dynamic capacity: 200-250 kg.
Sheet thickness: body: and drawers: 1.2 mm.
Ergonomic handle and rubber cover.
Electrostatic painting.

Aplicações | Aplicación | Application

- Armazenamento e transporte de ferramentas manuais, peças e acessórios.
- Almacenamiento y transporte de herramientas manuales y accesorios.
- Storage and transportation of hand tools and accessories.



REF.	PESO WEIGHT	Medidas Dimensiones Dimensions (mm)				
		A	B	C	D	E
● 44950/008	66,43 kg	1.000	848	460	420	645
● 44950/208	66,43 kg	1.000	848	460	420	645
● 44950/308	66,43 kg	1.000	848	460	420	645
● 44950/408	66,43 kg	1.000	848	460	420	645
● 44950/009	58,97 kg	1.000	848	460	420	645
● 44950/209	58,97 kg	1.000	848	460	420	645
● 44950/309	58,97 kg	1.000	848	460	420	645
● 44950/409	58,97 kg	1.000	848	460	420	645

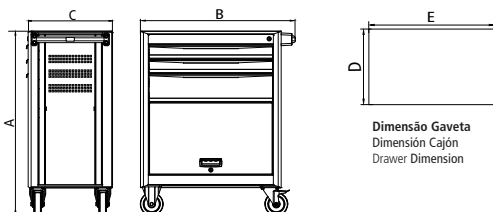

Informações gerais | Informaciones generales | General information:

Estrutura com paredes reforçadas.
Gavetas com corrediças telescópicas.
Rodas dianteiras fixas de borracha com 125 mm de diâmetro.
Rodas traseiras giratórias de borracha com 125 mm de diâmetro.
Rodas traseiras providas de freio individual.
Capacidade de carga máxima por gaveta: com altura de 75 mm: 20 kg | com altura de 155 mm: 30 kg.
Capacidade estática: 400 kg.
Capacidade dinâmica: 300-350 Kg.
Espessuras das chapas: corpo e gavetas: 1,2 mm.
Acompanha puxador ergonômico e lâmina de borracha para tampo superior.
Pintura eletrostática.

Estructura con paredes reforzadas.
Cajones con rieles telescópicos.
Ruedas delanteras fijas de goma de 125 mm de diámetro.
Ruedas traseras giratorias de goma de 125 mm de diámetro.
Ruedas traseras con freno individual.
Capacidad de carga máxima por cajón: con altura de 75 mm: 20 kg | con altura de 155 mm: 30 kg.
Capacidad estática: 400 kg; Capacidad dinámica: 300-350 kg.
Espesor de las chapas: estructura y cajones: 1,2 mm.
Tirador ergonómico y cubierta de goma.
Pintura electrostática.

Body with reinforced structure.
Drawers with ball bearing slides.
Rubber fixed front wheels with diameter of 125 mm.
Rubber swivel rear wheels with diameter of 125 mm.
Rear wheels equipped with individual brake.
Drawer capacity: 75 mm high: 20 kg | 155 mm high: 30 kg.
Static capacity: 400 kg; Dynamic capacity: 300-350 kg.
Sheet thickness: body and drawers: 1.2 mm.
Ergonomic handle and rubber cover.
Electrostatic painting.

Aplicações | Aplicación | Application

- Armazenamento e transporte de ferramentas manuais, peças e acessórios.
- Almacenamiento y transporte de herramientas manuales y accesorios.
- Storage and transportation of hand tools and accessories.

Cores disponíveis
Colores disponibles
Available colors:



Carro para ferramentas Carro para herramientas | Tool cabinet

Advantage
SUPER

1 PORTA
PUERTA
DOOR

3 GAVETAS
CAJONES
DRAWERS

44950/008 /208
/308 /408

Dois gavetas com 75 mm de altura.
Uma gaveta com 155 mm de altura.
Uma porta na parte inferior do carro.
Trancas para as gavetas e porta.

Dos cajones de 75 mm de altura.
Un cajón de 155 mm de altura.
Una puerta en la parte inferior del carro.
Trabas para los cajones y puertas.

Two drawers 75 mm high.
One drawer 155 mm high.
One door in lower part of tool cabinet.
Locking system with key for drawers and door.



1 PORTA
PUERTA
DOOR

3 GAVETAS
CAJONES
DRAWERS

44950/009 /209
/309 /409

Quatro gavetas com 75 mm de altura.
Uma gaveta com 155 mm de altura.
Uma porta na parte inferior do carro.
Trancas para as gavetas e porta.

Cuatro cajones de 75 mm de altura.
Un cajón de 155 mm de altura.
Una puerta en la parte inferior del carro.
Trabas para los cajones y puertas.

Four drawers 75 mm high.
One drawer 155 mm high.
One door in lower part of tool cabinet.
Locking system with key for all drawers and door.



Carro para ferramentas

Carro para ferramentas | Tool cabinet

Advantage
SUPER



7 GAVETAS
CAJONES
DRAWERS

44950/011 /211
/311 /411

Duas gavetas com 75 mm de altura.
Uma gaveta com 155 mm de altura.
Uma porta na parte inferior do carro.
Trancas para as gavetas e porta.

Dos cajones de 75 mm de altura.
Un cajón de 155 mm de altura.
Una puerta en la parte inferior del carro.
Trabas para los cajones y puertas.

Two drawers 75 mm high.
One drawer 155 mm high.
One door in lower part of tool cabinet.
Locking system with key for drawers and door.



8 GAVETAS
CAJONES
DRAWERS

44950/012 /212
/312 /412

Sete gavetas com 75 mm de altura.
Uma gaveta com 155 mm de altura.
Trancas para as gavetas.

Siete cajones de 75 mm de altura.
Un cajón de 155 mm de altura.
Trabas para los cajones.

Seven drawers 75 mm high.
One door 155 mm high.
Locking system with key for all drawers.

REF.	PESO WEIGHT	Medidas Dimensiones Dimensions (mm)				
		A	B	C	D	E
● 44950/011	70,00 kg	1.000	848	460	420	645
● 44950/211	70,00 kg	1.000	848	460	420	645
● 44950/311	70,00 kg	1.000	848	460	420	645
● 44950/411	70,00 kg	1.000	848	460	420	645
● 44950/012	96,50 kg	1.000	848	460	420	645
● 44950/212	96,50 kg	1.000	848	460	420	645
● 44950/312	96,50 kg	1.000	848	460	420	645
● 44950/412	96,50 kg	1.000	848	460	420	645

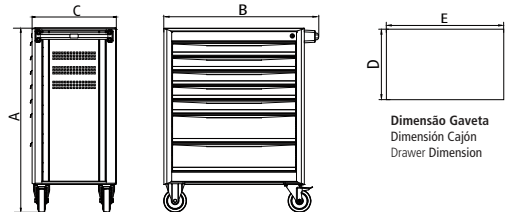

Informações gerais | Informaciones generales | General information:

Estrutura com paredes reforçadas.
Gavetas com corrediças telescópicas.
Rodas dianteiras fixas de borracha com 125 mm de diâmetro.
Rodas traseiras giratórias de borracha com 125 mm de diâmetro.
Rodas traseiras providas de freio individual.
Capacidade de carga máxima por gaveta: com altura de 75 mm: 20 kg |
com altura de 155 mm: 30 kg.
Capacidade estática: 400 kg.
Capacidade dinâmica: 300-350 kg.
Espessuras das chapas: corpo e gavetas: 1,2 mm.
Acompanha puxador ergonômico e lâmina de borracha para tampo superior.
Pintura eletrostática.

Estructura con paredes reforzadas.
Cajones con rieles telescópicos.
Ruedas delanteras fijas de goma de 125 mm de diámetro.
Ruedas traseras giratorias de goma de 125 mm de diámetro.
Ruedas traseras con freno individual.
Capacidad de carga máxima por cajón: con altura de 75 mm: 20 kg |
con altura de 155 mm: 30 kg
Capacidad estática: 400 kg; Capacidad dinámica: 300-350 kg.
Espesor de las chapas: estructura y cajones: 1,2 mm.
Tirador ergonómico y cubierta de goma.
Pintura electrostática.

Body with reinforced structure.
Drawers with ball bearing slides.
Rubber fixed front wheels with diameter of 125 mm.
Rubber swivel rear wheels with diameter of 125 mm.
Rear wheels equipped with individual brake.
Drawer capacity: 75mm high: 20 kg | 155 mm high: 30 kg.
Static capacity: 400 Kg; Dynamic capacity: 300-350 kg.
Sheet thickness: body and drawers: 1.2 mm.
Ergonomic handle and rubber cover.
Electrostatic painting.

Aplicações | Aplicación | Application

- Armazenamento e transporte de ferramentas manuais, peças e acessórios.
- Almacenamiento y transporte de herramientas manuales y accesorios.
- Storage and transportation of hand tools and accessories.

Cores disponíveis
Colores disponibles
Available colors:



REF.	PESO WEIGHT	Medidas Dimensiones Dimensions (mm)				
		A	B	C	D	E
44965/001	58,00 kg	1.000	848	460	420	645

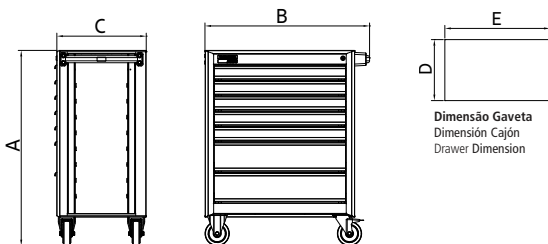

Dimensão Gaveta
Dimensión Cajón
Drawer Dimension

INOX
Series



7 GAVETAS
CAJONES
DRAWERS



Corrediças telescópicas que garantem maior abertura da gaveta.

Rieles telescópicos que garantizan mayor apertura del cajón.

Ball bearing slides that assure allow maximum of the drawer opening.



Acompanha puxador ergonómico e lâmina de borracha para tampo superior.

Tirador ergonómico y cubierta de goma.

Ergonomic handle and rubber cover.



Rodas giratórias, de borracha com 125 mm de diâmetro, providas de freio.

Ruedas giratorias, de goma de 125 mm de diámetro, con freno individual.

Rubber swivel wheels with a diameter of 125 mm, with brakes.

Aplicações | Application | Aplicación

- Armazenamento e transporte de ferramentas manuais, peças e acessórios.
- Ideal para realizar manutenções em indústrias de bebidas, químicas, farmacêuticas e em estaleiros.
- Almacenamiento y transporte de herramientas manuales y accesorios.
- Ideal para realizar mantenimiento en industrias de bebidas, químicas, farmacéuticas y en astilleros.
- Storage and transportation of hand tools and accessories.
- Suitable to work in shipyards and chemical, pharmaceutical and beverage industries.

Carro em Inox para Ferramentas

Carro en Acero Inoxidable para Herramientas
Stainless Tool Cabinet

Informações gerais | Informaciones generales | General information:

Sete gavetas com corrediças telescópicas.
 Cinco gavetas com 75 mm de altura e duas gavetas com 155 mm de altura.
 Tranca única para todas gavetas - possibilitando a abertura de apenas uma gaveta por vez.
 2 Rodas giratórias, de borracha com 125 mm de diâmetro, providas de freio.
 2 Rodas fixas, de borracha com 125 mm de diâmetro.
 Capacidade de carga máxima por gaveta: altura de 75 mm: 20 kg | altura de 155 mm: 30 kg
 Capacidade estática: 400 kg; Capacidade dinâmica: 300 - 350 Kg.
 Acompanha puxador ergonómico e lâmina de borracha para tampo superior.

Siete cajones con rieles telescópicos.
 Cinco cajones de 75 mm de altura y dos de 155 mm.
 Traba única para todos cajones que permite abrir solo un cajón a la vez
 2 Ruedas giratorias, de goma de 125 mm de diámetro, con freno individual.
 2 Ruedas fijas, de goma de 125 mm de diámetro,
 Capacidad de carga máxima por cajón: con altura de 75 mm: 20 kg | con altura de 155 mm: 30 kg.
 Capacidad estática: 400 kg; Capacidad dinámica: 300 - 350 Kg.
 Tirador ergonómico y cubierta de goma.

Seven drawers with ball bearing slides.
 Five drawers 75 mm high and two 155 mm high.
 Single locking system, allows opening just one drawer at time.
 2 Rubber swivel wheels with a diameter of 125 mm, with brakes.
 2 Rubber fixed wheels with a diameter of 125 mm.
 Drawer capacity: 75 mm high: 20 kg | 155 mm high: 30 kg.
 Static capacity: 400 kg; Dynamic capac.: 300 - 350 Kg.
 Ergonomic handle and rubber cover.



Bancada móvel 6 gavetas e 1 porta

Bancada móvel 6 cajones y 1 puerta
6 drawers 1 door Mobile workbench



1

PORTA
PUERTA
DOOR

6

GAVETAS
CAJONES
DRAWERS



Trancas para as gavetas e portas.

Traba para los cajones y puertas.

Doors and drawers with key locking system and plastic handle.



Prateleiras móveis que possibilitam diferentes configurações de montagem.

Estantes móveis que permiten diferentes configuraciones de montaje.

Mobile racks that enables different mounting configurations



Sistema especial de travamento de gavetas.

Sistema especial de traba de los cajones.

Special system to lock the drawers.



Corrediças telescópicas que garantem maior abertura da gaveta.

Rieles telescópicos que garantizan mayor apertura del cajón.

Ball bearing slides that assure allow maximum of the drawer opening.

Aplicações | Aplicación | Application

- Armazenamento e transporte de ferramentas manuais, peças e acessórios.
- Almacenamiento y transporte de herramientas manuales y accesorios.
- Storage and transportation of hand tools and accessories.

REF.	PESO WEIGHT	Medidas Dimensiones Dimensions (mm)					
		A	B	C	D	E	F
44959/001	134,00 kg	900	600	1.085	1.150	420	445
44959/201	134,00 kg	900	600	1.085	1.150	420	445
44959/301	134,00 kg	900	600	1.085	1.150	420	445
44959/401	134,00 kg	900	600	1.085	1.150	420	445

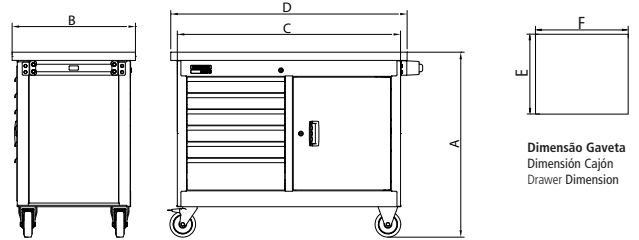

Dimensão Gaveta
Dimensión Cajón
Drawer Dimension

Informações gerais | Informaciones generales | General information:

Cores disponíveis
Colores disponibles
Available colors:



Estrutura com paredes reforçadas.
Seis gavetas com corrediças telescópicas.
Cinco gavetas com 75 mm de altura, uma com 155 mm e uma porta.
Trancas para gavetas e porta.
Rodas dianteiras fixas e traseiras giratórias.
Rodas traseiras providas de freio individual.
Capacidade de carga máxima por gaveta com altura de 75 mm: 20 Kg | com altura de 155 mm: 30 kg.
Capacidade estática: 700 Kg; Capacidade dinâmica: 500 kg.
Espessuras das chapas - Corpo e gavetas: 1,2 mm.
As maletas, carros e bancadas são testados em ensaios de carga, para garantir sua resistência durante a utilização na oficina ou indústria.
A pintura eletrostática forma uma película protetiva que garante um acabamento excelente e resistência à corrosão.
As gavetas que estão na linha de carros e bancadas, possuem corrediça tipo telescópica.
Armazenamento e transporte de ferramentas manuais, peças e acessórios.
Puxador ergonômico.
As ferramentas são produzidas e testadas conforme normas específicas.

Estructura con paredes reforzadas.
Seis cajones con rieles telescópicos.
Cinco cajones de 75 mm de altura, dos de 155 mm y una puerta.
Trabas para los cajones y puerta.
Ruedas delanteras fijas y traseras giratorias.
Ruedas traseras con freno individual.
Capacidad de carga máxima por cajón: con altura de 75 mm: 20 kg | con altura de 155 mm: 30 kg.
Capacidad estática: 700 kg; Capacidad dinámica: 500 kg.
Espesor de las chapas: estructura y cajones: 1,2 mm.
Las cajas, carros y bancadas son testados en ensayos de carga, para garantizar su resistencia durante la utilización en talleres mecánicos o industria.
La pintura electrostática forma una capa protectora que garantiza un excelente acabado y resistencia a la corrosión.
Los cajones que están en la línea de carros y bancadas poseen corredizas telescópicas que son eficaces e el movimiento del cajón y permiten total apertura.
Almacenamiento y transporte de herramientas manuales y accesorios.
Tirador ergonómico
Las herramientas son producidas y testadas bajo normas específicas.

Body with reinforced structure.
Six drawers with ball bearing slides.
Five drawers 75 mm high, one 155 mm high and one door.
Locking system with key for all drawers and door.
Locking system with key for all drawers.
Rear wheels equipped with individual brake.
Drawer capacity: 75 mm high: 20 kg / 155 mm high: 30 kg.
Static capacity: 700 kg; Dynamic capacity: 500 kg.
Sheet thickness: body and drawers: 1.2 mm.
The boxes, cabinets and workbenches are load tested, to ensure their strength when used by mechanics or in industry.
The electrostatic paint provides a protective layer that ensures an excellent finish and is resistant to rust.
The drawers that are in the cabinets and workbenches have Ball bearing slides, which allow efficient drawer movement and complete opening.
Storage and transportation of hand tools and accessories.
Ergonomic handle.
Tools are produced and tested according to specific standards.



REF.	PESO WEIGHT	Medidas Dimensiones Dimensions (mm)					
		A	B	C	D	E	F
44959/002	160,00 kg	900	600	1.085	1.150	420	445
44959/202	160,00 kg	900	600	1.085	1.150	420	445
44959/302	160,00 kg	900	600	1.085	1.150	420	445
44959/402	160,00 kg	900	600	1.085	1.150	420	445

Bancada móvel 11 gavetas

Bancada móvel 11 cajones

11 drawers Mobile workbench

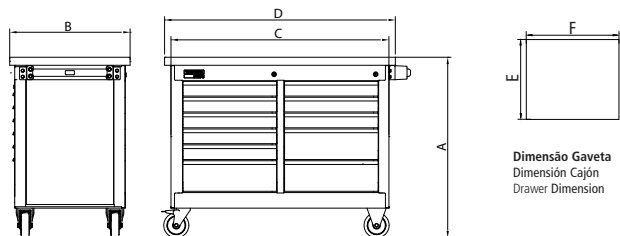

Dimensão Gaveta
Dimensión Cajón
Drawer Dimension



Informações gerais | Informaciones generales | General information:

Estrutura com paredes reforçadas.
Onze gavetas com corrediças telescópicas.
8 gavetas com 75 mm de altura e 3 com 155 mm de altura.
Trancas para as gavetas.
Rodas dianteiras fixas e traseiras giratórias.
Rodas traseiras providas de freio individual.
Capacidade de carga máxima por gaveta com altura de 75 mm: 20 kg / com altura de 155 mm: 30 kg.
Capacidade estática: 700 kg.
Capacidade dinâmica: 500 kg.
Espessuras das chapas - Corpo e gavetas: 1,2 mm.
As maletas, carros e bancadas são testados em ensaios de carga, para garantir sua resistência durante a utilização na oficina ou indústria.
A pintura eletrostática forma uma película protetiva que garante um acabamento excelente e resistência à corrosão.
As gavetas que estão na linha de carros e bancadas, possuem corrediça tipo telescópica.
Armazenamento e transporte de ferramentas manuais, peças e acessórios.
Puxador ergonómico.
As ferramentas são produzidas e testadas conforme normas específicas.

Cores disponíveis
Colores disponibles
Available colors:



11 GAVETAS
CAJONES
DRAWERS

Estrutura com paredes reforçadas.
Once cajones con rieles telescópicos.
8 cajones de 75 mm de altura y 3 de 155 mm.
Trabas para los cajones.
Ruedas delanteras fijas y traseras giratorias.
Ruedas traseras con freno individual.
Capacidad de carga máxima por cajón: con altura de 75 mm: 20 kg / con altura de 155 mm: 30 kg.
Capacidad estática: 700 kg.
Capacidad dinámica: 500 kg.
Espesor de las chapas: estructura y cajones: 1,2 mm.
Las cajas, carros y bancadas son testados en ensayos de carga, para garantizar su resistencia durante la utilización en talleres mecánicos o industria.
La pintura electrostática forma una capa protectora que garantiza un excelente acabado y resistencia a la corrosión.
Los cajones que están en la línea de carros y bancadas poseen corredizas telescópicas que son eficaces e el movimiento del cajón y permiten total apertura.
Almacenamiento y transporte de herramientas manuales y accesorios.
Tirador ergonómico
Las herramientas son producidas y testadas bajo normas específicas.

Body with reinforced structure.
Eleven drawers with ball bearing slides.
8 drawers 75 mm high and 3 drawers 155 mm high.
Locking system with key for all drawers.
Rear wheels equipped with individual brake.
Drawer capacity: 75 mm high: 20 kg / 155 mm high: 30 kg.
Static capacity: 700 kg.
Dynamic capacity: 500 kg.
Sheet thickness: body and drawers: 1,2 mm.
The boxes, cabinets and workbenches are load tested, to ensure their strength when used by mechanics or in industry.
The electrostatic paint provides a protective layer that ensures an excellent finish and is resistant to rust.
The drawers that are in the cabinets and workbenches have Ball bearing slides, which allow efficient drawer movement and complete opening.
Storage and transportation of hand tools and accessories.
Ergonomic handle.
Tools are produced and tested according to specific standards.



Trancas para as gavetas e portas.

Traba para los cajones y puertas.

Doors and drawers with key locking system and plastic handle.



Prateleiras móveis que possibilitam diferentes configurações de montagem.

Estantes móviles que permiten diferentes configuraciones de montaje.

Mobile racks that enables different mounting configurations



Sistema especial de travamento de gavetas.

Sistema especial de traba de los cajones.

Special system to lock the drawers.



Corrediças telescópicas que garantem maior abertura da gaveta.

Rieles telescópicos que garantizan mayor apertura del cajón.

Ball bearing slides that assure allow maximum of the drawer opening.

Aplicações | Aplicación | Application

- Armazenamento e transporte de ferramentas manuais, peças e acessórios.
- Almacenamiento y transporte de herramientas manuales y accesorios.
- Storage and transportation of hand tools and accessories.



Suporte para lubrificantes

Suporte para botes | Bottle holder



Estrutura em chapas de aço conformadas.
Espessuras das chapas de 1,08 mm.
Pintura eletrostática.

Estructura en chapas de acero conformadas.
Espesor de las chapas de 1,08 mm.
Pintura electrostática.

Conformed steel sheets structure.
1.08 mm sheet thickness.
Electrostatic painting.



REF.	PESO WEIGHT	Medidas Dimensiones Dimensions (mm)			
		A	B	C	D
44954/991	590 g	115	265	85	75

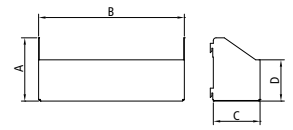

Aplicações | Aplicación | Application

- Próprio para os carros organizadores da Tramontina Pro.
- Utilizado para armazenar lubrificantes, produtos de limpeza, sprays, etc.
- Propio para los carros de herramientas Tramontina Pro.
- Para almacenar aerosoles, productos de limpieza, pulverizadores, etc.
- Specially for Tramontina Pro roller cabinets.
- For storing aerosols, cleaning products, sprays, etc.

Suporte para papel toalha

Suporte para rolo de papel | Paper roll holder



Estrutura em barras de aço dobradas.
Pintura eletrostática.

Estructura en barras de acero dobladas.
Pintura electrostática.

Steel bars bent structure.
Electrostatic painting.



REF.	PESO WEIGHT	Medidas Dimensiones Dimensions (mm)		
		A	B	C
44954/992	310 g	334	254	139

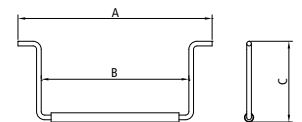

Aplicações | Aplicación | Application

- Próprio para os carros organizadores da Tramontina Pro.
- Utilizado para armazenar rolo de papel para limpeza durante o trabalho.
- Propio para los carros de herramientas Tramontina Pro.
- Para almacenar rollos de papel para la limpieza durante el trabajo.
- Specially for Tramontina Pro roller cabinets.
- For storing paper roll used for cleaning during works.

Suporte para catálogo e documentos

Suporte para catálogo y documentos

Catalog and documents holder



Estrutura em chapas de aço conformadas.
Espessuras das chapas de 1,08 mm.
Pintura eletrostática.

Estructura en chapas de acero conformadas.
Espesor de las chapas de 1,08 mm.
Pintura electrostática.

Conformed steel sheets structure.
1.08 mm sheet thickness.
Electrostatic painting.



REF.	PESO WEIGHT	Medidas Dimensiones Dimensions (mm)			
		A	B	C	D
44954/993	1,150 g	257	265	217	65

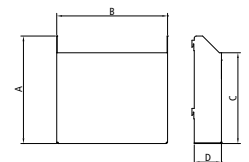

Aplicações | Aplicación | Application

- Próprio para os carros organizadores da Tramontina Pro.
- Utilizado para armazenar catálogos, documentos, desenhos, informações técnicas, etc.
- Propio para los carros de herramientas Tramontina Pro.
- Para almacenar catálogos, documentos, dibujos, información técnica, etc.
- Specially for Tramontina Pro roller cabinets.
- For storing catalogs, documents, drawings, technical information, etc.



REF.	PESO WEIGHT	Medidas Dimensiones Dimensions (mm)				
		A	B	C	D	E
● 44951/002	19,85 kg	910	710	405	345	485
● 44951/004	19,85 kg	910	710	405	345	485
● 44951/005	19,85 kg	910	710	405	345	485
● 44951/006	19,85 kg	910	710	405	345	485

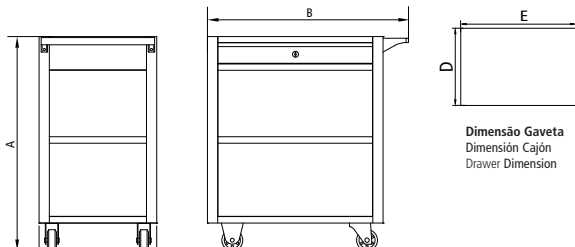

Carro para ferramentas aberto Carro para herramientas | Tool cabinet

Advantage
Series

1 GAVETA
CAJONE
DRAWER

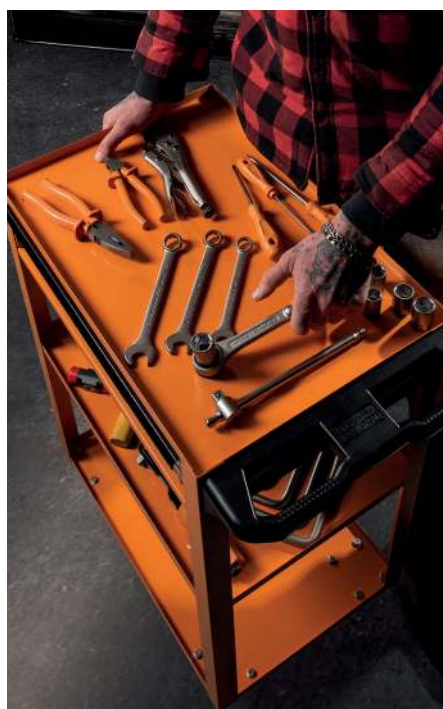

Corrediças telescópicas que garantem maior abertura da gaveta.

Rieles telescópicos que garantizan mayor apertura del cajón.

Ball bearing slides that assure allow maximum of the drawer opening.

Cores disponíveis
Colores disponibles
Available colors:



Estrutura com paredes reforçadas.
Gaveta com corrediça telescópica.
Tranca para a gaveta, chave inclusa.
Três bandejas.
Rodas dianteiras fixas em borracha com 80 mm de diâmetro.
Rodas traseiras giratórias em borracha com 80 mm de diâmetro.
Capacidade de carga máxima da gaveta: 20 kg.
Capacidade estática: 200 kg.
Capacidade dinâmica: 100 - 150 kg.
Espessura das chapas: corpo, bandeja e gaveta: 0,9 mm.
Puxador plástico.
Pintura eletrostática.

Estructura con paredes reforçadas.
Cajón con rieles telescópicos.
Tres bandejas.
Traba para el cajón.
Ruedas delanteras fijas de goma de 80 mm de diámetro.
Ruedas traseras giratorias de goma de 80 mm de diámetro.
Capacidad de carga máxima del cajón: 20 kg.
Capacidad estática: 200 kg.
Capacidad dinámica: 100 - 150 kg.
Espesor de las chapas: estructura, bandeja y cajón: 0,9 mm.
Mango plástico.
Pintura electrostática.

Body with reinforced structure.
Drawer with ball bearing slides.
Three shelves.
Locking system with key for the drawer.
Rubber fixed front wheels with diameter of 80 mm.
Rubber swivel rear wheels with diameter of 80 mm.
Drawer capacity: 20 kg.
Static capacity: 200 kg.
Dynamic capacity: 100 - 150 kg.
Sheet thickness: body, shelves and drawer: 0.9 mm.
Plastic handle.
Electrostatic painting.

Aplicações | Aplicación | Application

- Armazenamento e transporte de ferramentas manuais, peças e acessórios.
- Almacenamiento y transporte de herramientas manuales y accesorios.
- Storage and transportation of hand tools and accessories.

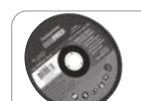

Carro aberto com 30 caixas BIN número 3

Carro abierto con 30 cubetas BIN numero 3

Tool cabinet with 30 BIN boxes number 3

Advantage
Gaveta**1** GAVETA
CAJONE
DRAWERCores disponíveis
Colores disponibles
Available colors:

REF.	PESO WEIGHT	Medidas Dimensiones Dimensions (mm)				
		A	B	C	D	E
44951/010	32,50 kg	1.400	710	400	345	485
44951/210	32,50 kg	1.400	710	400	345	485
44951/310	32,50 kg	1.400	710	400	345	485
44951/410	32,50 kg	1.400	710	400	345	485

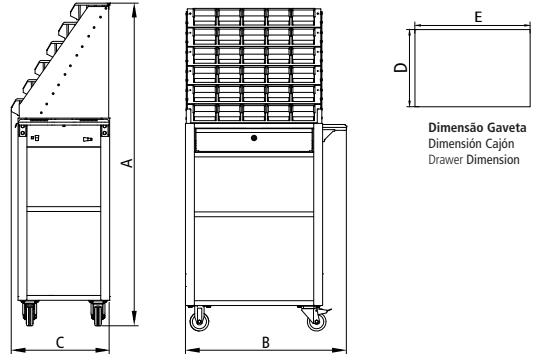
Dimensão Gaveta
Dimensión Cajón
Drawer Dimension**Informações gerais | Informaciones generales |
General information:**

Estrutura em chapas de aço conformadas.
Tranca para a gaveta com chave.
Pintura eletrostática a pó.
Capacidade de carga máxima para a gaveta: 20 kg.
Capacidade de carga estática total: 200 kg.
Capacidade de carga dinâmica total: 80-100 kg.
Espessura das chapas da estrutura e gaveta: 0,9 mm.
Possui 30 caixas BIN número 3, 2 bandejas e uma gaveta com corredeiras telescópicas.
Rodas dianteiras fixas em borracha com 125 mm de diâmetro.
Rodas traseiras giratórias em borracha com 125 mm de diâmetro.

Estructura en chapas de acero conformadas.
Traba para el cajón con llave.
Pintura electrostática.
Capacidad de carga máxima del cajón: 20 kg.
Capacidad de carga estática total: 200 kg.
Capacidad de carga dinámica total: 80-100 kg.
Espesor de las chapas de la estructura y cajón: 0,9 mm.
Tienes 30 cubetas BIN número 3, 2 bandejas y un cajón con rieles telescópicos.
Ruedas delanteras fijas de goma en plástico con 125 mm de diámetro.
Ruedas traseras giratorias de gom con 125 mm de diámetro.

Conformed steel sheets structure.
Locks for the drawer with key.
Electrostatic painting.
Drawer load capacity: 20 kg.
Static load capacity: 200 kg.
Dynamic load capacity: 80-100 kg.
Structure and drawer sheet thickness: 0.9 mm.
It has 30 plastic BIN boxes number 3, 2 shelves and one drawer with ball bearing slides.
Rubber fixed front wheels with diameter of 125 mm.
Rubber swivel rear wheels with diameter of 125 mm.

Corredeiras telescópicas que
garantem maior abertura da
gaveta.Rieles telescópicos que
garantizan mayor apertura
del cajón.Ball bearing slides that assure
allow maximum of the drawer
opening.**Aplicações | Aplicación | Application**

- Armazenamento de componentes pequenos, tais como parafusos, porcas e arruelas.
- Almacenamiento de piezas pequeñas, tales como tornillos, tuercas y arandelas.
- Storage of small components such as, screws, nuts and washers.



REF.	PESO WEIGHT	Medidas Dimensiones Dimensions (mm)				
		A	B	C	D	E
● 44951/008	19,85 kg	1150	770	550	486	294
● 44951/208	19,85 kg	1150	770	550	486	294
● 44951/308	19,85 kg	1150	770	550	486	294
● 44951/408	19,85 kg	1150	770	550	486	294

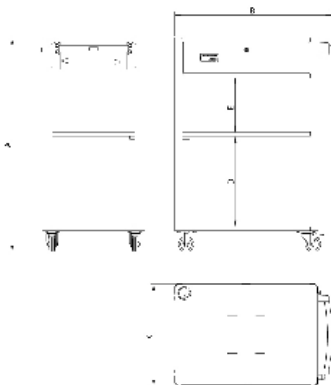

Cores disponíveis
Colores disponibles
Available colors:



Informações gerais | Informaciones generales | General information:

Estrutura com paredes reforçadas.
Gavetas com corrediça telescópica.
Porta para gavetas com tranca e chave inclusa.
Três bandejas.
Calha para passagem de fios.
Rodas dianteiras fixas em borracha.
Rodas traseiras giratórias em borracha.
Capacidade de carga máxima das gavetas: 20 kg.
Capacidade estática: 200 kg; Capacidade dinâmica: 100-150 kg.
Espessura das chapas: corpo, bandeja e gaveta: 1,2 mm.
Puxador plástico

Estructura con paredes reforzadas.
Cajones con rieles telescópicos.
Puerta para cajones con cerradura y llave inclusa
Tres bandejas.
Riel de paso de hilos.
Ruedas delanteras fijas de goma.
Ruedas traseras giratorias de goma.
Capacidad de carga máxima del cajones: 20 kg.
Capacidad estática: 200 kg; Capacidad dinámica: 100 - 150 kg.
Espesor de las chapas: estructura, bandejas y cajones: 1,2 mm.
Mango plástico.

Body with reinforced structure.
Drawers with ball bearing slides.
Door of drawers with lock and key included
Three shelves.
Cable outlet
Rubber fixed front wheels.
Rubber swivel rear wheels.
Drawer capacity: 20 kg.
Static capacity: 200 kg; Dynamic capacity: 100-150 kg.
Sheet thickness: body, shelves and drawer: 1.2 mm.
Plastic handle.

Rack móvel aberto para computador Rack movible abierto para computadora Open mobile rack for computer

Advantage
Series



1 PORTA
PUERTA
DOOR

2 GAVETAS
CAJONES
DRAWERS

Dimensão Gaveta 1
Dimensión Cajón 1
Drawer Dimension 1

645 x 326 mm

Dimensão Gaveta 2
Dimensión Cajón 2
Drawer Dimension 2

645 x 420 mm



Corrediças telescópicas que garantem maior abertura da gaveta.

Rieles telescópicos que garantizan mayor apertura del cajón.

Ball bearing slides that assure allow maximum of the drawer opening.

Aplicações | Aplicación | Application

- Utilizado para armazenamento e transporte de computador.
- Utilizado para guardar y transportar la computadora.
- Used to store and transport computers.



Rodízio articulado para carros Advantage

Rueda articulada para carros Advantage | Articulated caster wheel for Advantage tool cabinets – 125 mm



Rodízio articulado para carros organizadores.
Corpo em aço carbono.
Roda de borracha.
125 mm de diâmetro.
40 mm de espessura.
Com sistema de freio.

Rueda articulada para carros de herramientas.
Cuerpo en acero carbono.
Externo en goma.
125 mm de diámetro.
40 mm de espesor.
Con sistema de freno.

Articulated caster wheel for tool cabinets.
Carbon steel frame.
Rubber wheel.
125 mm diameter.
40 mm thickness.
Includes brake system.

REF.	PESO WEIGHT	Medidas Dimensiones Dimensions (mm)				
		A	B	C	D	E
44950/980	1,900 kg	160	161	86	40	125

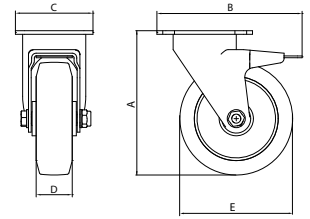

Aplicações | Aplicación | Application

- Próprio para os carros organizadores da Tramontina PRO Advantage Series e Advantage Super Series.
- Propio para los carros de herramientas Tramontina PRO Advantage Series y Advantage Super Series.
- Suitable for Tramontina PRO tool cabinet. Advantage Series and Advantage Super Series.

Rodízio fixo para carros Advantage

Rueda fija para carros Advantage | Fixed caster wheel for Advantage tool cabinets – 125 mm



Rodízio articulado para carros organizadores.
Corpo em aço carbono.
Roda de borracha.
125 mm de diâmetro.
40 mm de espessura.
Com sistema de freio.

Rueda articulada para carros de herramientas.
Cuerpo en acero carbono.
Externo en goma.
125 mm de diámetro.
40 mm de espesor.
Con sistema de freno.

Articulated caster wheel for tool cabinets.
Carbon steel frame.
Rubber wheel.
125 mm diameter.
40 mm thickness.
Includes brake system.

REF.	PESO WEIGHT	Medidas Dimensiones Dimensions (mm)				
		A	B	C	D	E
44950/981	1,640 kg	160	105	88	40	125

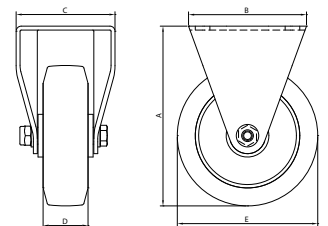

Aplicações | Aplicación | Application

- Próprio para os carros organizadores da Tramontina PRO Advantage Series e Advantage Super Series.
- Propio para los carros de herramientas Tramontina PRO Advantage Series y Advantage Super Series.
- Suitable for Tramontina PRO tool cabinet. Advantage Series and Advantage Super Series.



REF.	PESO WEIGHT	Medidas Dimensiones Dimensions (mm)				
		A	B	C	D	E
44950/982	850 g	112	100	80	30	80

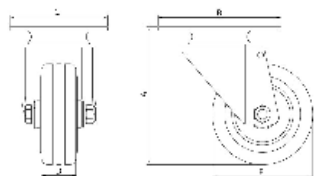

Aplicações | Aplicación | Application

- Próprio para os carros organizadores da Tramontina PRO Advantage Series e Advantage Super Series.
- Propio para los carros de herramientas Tramontina PRO Advantage Series y Advantage Super Series.
- Suitable for Tramontina PRO tool cabinet. Advantage Series and Advantage Super Series.

Rodízio articulado para carros Advantage

Rueda articulada para carros Advantage | Articulated caster wheel for Advantage tool cabinets – 80 mm



Rodízio articulado para carros organizadores.
Corpo em aço carbono.
Roda de borracha.
80 mm de diâmetro.
30 mm de espessura.

Rueda articulada para carros de herramientas.
Cuerpo en acero carbono.
Externo en goma.
80 mm de diámetro.
30 mm de espesor.

Articulated caster wheel for tool cabinets.
Carbon steel frame.
Rubber wheel.
80 mm diameter.
30 mm thickness.

REF.	PESO WEIGHT	Medidas Dimensiones Dimensions (mm)				
		A	B	C	D	E
44950/983	750 g	112	102	85	30	80

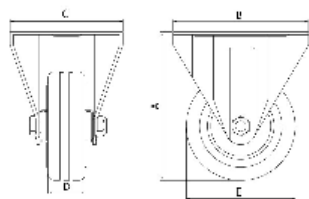

Aplicações | Aplicación | Application

- Próprio para os carros organizadores da Tramontina PRO Advantage Series e Advantage Super Series.
- Propio para los carros de herramientas Tramontina PRO Advantage Series y Advantage Super Series.
- Suitable for Tramontina PRO tool cabinet. Advantage Series and Advantage Super Series.

Rodízio fixo para carros Advantage

Rueda fija para carros Advantage | Fixed caster wheel for Advantage tool cabinets – 80 mm



Rodízio articulado para carros organizadores.
Corpo em aço carbono.
Roda de borracha.
80 mm de diâmetro.
30 mm de espessura.

Rueda articulada para carros de herramientas.
Cuerpo en acero carbono.
Externo en goma.
80 mm de diámetro.
30 mm de espesor.

Articulated caster wheel for tool cabinets.
Carbon steel frame.
Rubber wheel.
80 mm diameter.
30 mm thickness.



Caixa sanfonada

Caja porta herramientas | Tool box

Alças fixas | Manijas fijas | Fixed handles

**3**GAVETAS
CAJONES
DRAWERS

44952/000

**5**GAVETAS
CAJONES
DRAWERS

44952/001

**LANÇAMENTO**

NUEVO | NEW

**7**GAVETAS
CAJONES
DRAWERS

44952/002



REF.	PESO WEIGHT	Medidas Dimensiones Dimensions (mm)			
		A	B	C	D
44952/000	4,48 kg	300	525	200	220
44952/001	3,51 kg	265	525	210	170
44952/002	5,34 kg	350	502	207	286

*44952/002 - Lançamento | Nuevo | New

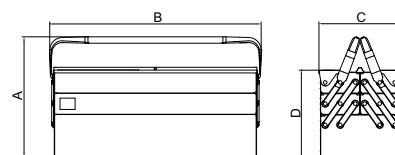
**Informações gerais | Informaciones generales |
General information:**

Pintura eletrostática.
Pintura electrostática.
Electrostatic painting.



Possibilita o uso de cadeado.
Posibilita el uso del candado.
Allow the use of padlock.

**Aplicações | Aplicación | Application**

- Armazenamento e transporte de ferramentas manuais, peças e acessórios.
- Almacenamiento y transporte de herramientas manuales y accesorios.
- Storage and transportation of hand tools and accessories.



REF.	PESO WEIGHT	Medidas Dimensiones Dimensions (mm)			
		A	B	C	D
44952/600	6,50 kg	400	560	210	218

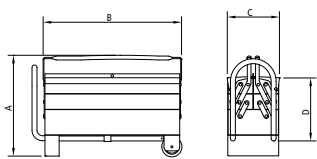

Aplicações | Aplicación | Application

- Armazenamento e transporte de ferramentas manuais, peças e acessórios. Devido a sua construção, é muito prática e de fácil movimentação.
- Almacenamiento y transporte de herramientas manuales y accesorios. Debido a su diseño es muy práctica y fácil de transportar.
- Storage and transportation of hand tools and accessories. Due to its structure, it offers a practical and easy transport.

Caixa sanfonada com rodas e puxador

Caja porta herramientas | Tool box

Alças fixas | Manijas fijas | Fixed handles

5 GAVETAS
CAJONES
DRAWERS



Possibilita o uso de cadeado.
Posibilita el uso del candado.
Allow the use of padlock.

Puxador retrátil.
Rodas de alta resistência.
Pintura eletrostática.

Tirador retrátil.
Ruedas de alta resistencia.
Pintura electrostática.

Retractable handle.
High resistance wheels.
Electrostatic painting.



REF.	PESO WEIGHT	Medidas Dimensiones Dimensions (mm)					
		A	B	C	D	E	F
44952/700	18,38 kg	404	390	390	270	330	345

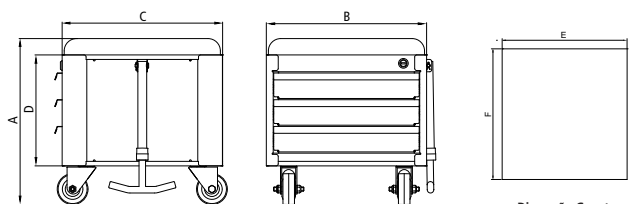

Dimensão Gaveta
Dimensión Cajón
Drawer Dimension

Caixa porta ferramentas CargoBox Comfort

Caja porta herramientas CargoBox Comfort |

CargoBox Comfort tool box

3 GAVETAS
CAJONES
DRAWERS



Estrutura metálica.
Três gavetas com 100% de abertura.
Puxador retrátil.
Almofada no tampo superior.
Rodas de alta resistência.
4 rodas giratórias, sendo 2 com freio.
Pintura eletrostática.

Estructura metálica.
Three cajones with 100% de abertura.
Tirador retrátil.
Almohada en la parte superior.
Ruedas de alta resistencia.
4 ruedas giratorias, dos de ellas con freno.
Pintura electrostática.

Metallic structure.
Three drawers with 100% opening.
Retractable handle.
Pad on the top.
High resistance wheels.
4 swivel wheels, 2 of which include breaks.
Electrostatic painting.

Aplicações | Aplicación | Application

- Armazenamento e transporte de ferramentas manuais, peças e acessórios. Devido a sua construção, é muito prática e de fácil movimentação.
- Almacenamiento y transporte de herramientas manuales y accesorios. Debido a su diseño es muy práctica y fácil de transportar.
- Storage and transportation of hand tools and accessories. Due to its structure, it offers a practical and easy transport.



Caixa sanfonada em aço Inox

Caja porta herramientas de acero inoxidable | Stainless steel tool box

Alças dobráveis | Manijas flexibles | Flexible handles

5 GAVETAS
CAJONES
DRAWERS



Produzida em chapas de aço inoxidável.
Cinco gavetas.
Alças dobráveis.

Producida en chapas de acero inoxidable.
Cinco cajones.
Manijas flexibles.

Produced in stainless steel sheets.
Five drawers.
Flexible handles.

REF.	PESO WEIGHT	Medidas Dimensiones Dimensions (mm)				
		A	B	C	D	E
44952/010	5,13 kg	320	525	210	232	215

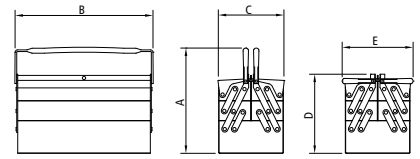

Sistema especial de trava na alça para facilitar o fechamento.

Sistema especial de trava en la manija para facilitar el cierre.
Special system in the handle to make the closing easier.

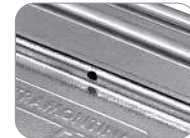

Possibilita o uso de cadeado.

Posibilita el uso del candado.
Allow the use of padlock.



Alças inteiriças com dobras especiais.

Manijas enteras con dobleces especiales (sin soldadura).
Handles with special bends (no welding).

Aplicações | Aplicación | Application

- Armazenamento e transporte de ferramentas manuais, peças e acessórios. Ideal para realizar manutenções em indústrias de bebidas, químicas, farmacêuticas e em estaleiros.
- Almacenamiento y transporte de herramientas manuales y accesorios. Ideal para realizar mantenimientos en industrias de bebidas, alimentaria, químicas, farmacéuticas y en astilleros.
- Storage and transportation of hand tools and accessories. Suitable for use in the maintenance departments in the food and drink, chemical and pharmaceutical industries and shipyards.

Maleta para ferramentas

Maletín porta herramientas | Tool case

Com rodinhas e puxador | Con ruedas y pujador | With casters and puller



Cantoneiras em aço carbono.
Placas de alumínio.
Rodinhas de borracha.
Cabo do puxador em plástico.
Guias do puxador em alumínio.
Possui divisória interna e placa porta-ferramentas.
Capacidade: 20 kg.

Cantonerías en acero carbono.
Placas de aluminio.
Ruedas de goma.
Mango de plástico.
Guía del pujador en aluminio.
Posee divisoria interna y placa porta herramientas.
Capacidad: 20 kg.

Carbon steel angles.
Aluminum boards.
Rubber casters.
Plastic handle.
Aluminum handle guides.
Available with internal divisions and tool holder board.
Capacity: 20 kg.

REF.	PESO WEIGHT	Medidas Dimensiones Dimensions (mm)		
		A	B	C
44952/040	7,19 kg	609	430	220

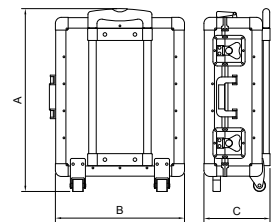

Aplicações | Aplicación | Application

- Armazenamento e transporte de ferramentas manuais, peças e acessórios.
- Almacenamiento y transporte de herramientas manuales y accesorios.
- Storage and transportation of hand tools and accessories.



REF.	PESO WEIGHT	Medidas Dimensiones Dimensions (mm)		
		A	B	C
44952/050	3,37 kg	330	460	155

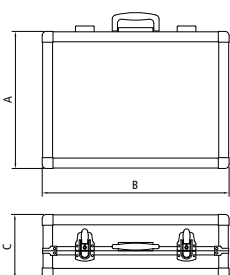

Maleta para ferramentas Maletín porta herramientas | Tool case



Cantoneiras em aço carbono.
Placas de alumínio.
Possui divisória interna e placa porta-ferramentas.
Capacidade: 15 kg.

Cantoneiras en acero carbono.
Placas en aluminio.
Posee división interna y placa porta
herramientas.
Capacidad: 15 kg.

Carbon steel angles.
Aluminum boards.
With internal divisions and tool holder
board.
Capacity: 15 kg.

Aplicações | Aplicación | Application

- Armazenamento e transporte de ferramentas manuais, peças e acessórios.
- Almacenamiento y transporte de herramientas manuales y accesorios.
- Storage and transportation of hand tools and accessories.



Coldre de cinto para parafusadeira

Funda de cinturón para atornillador | Power tool holster



REF.	PESO WEIGHT	Medidas Dimensiones Dimensions (mm)	
		A	B
44952/401	25 g	300	190

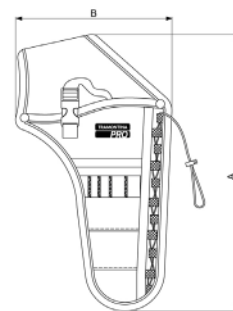

Produzido em nylon de alta resistência.
Compartimento para armazenamento e transporte de componentes diversos.
Cinta de fixação com engate plástico.
Cordão elástico ajustável.

Fabricada con nylon de alta resistencia.
Compartimiento para guardar y transportar componentes diversos.
Cinta de fijación con enganche plástico.
Cordón elástico ajustable.

Made of highly resistant nylon.
Pocket for storing and transporting assorted components.
Attachment belt with plastic clip.
Adjustable elastic cord.

Aplicações | Aplicación | Application

- Armazenamento e transporte de ferramentas manuais, peças e acessórios.
- Almacenamiento y transporte de herramientas manuales y accesorios.
- Storage and transportation of hand tools and accessories.

Cinto para ferramentas eletrícista

Cinturón para herramientas electricista

Electrician's tool pouch



REF.	PESO WEIGHT	Medidas Dimensiones Dimensions (mm)	
		A	B
44952/420	66 g	217	245

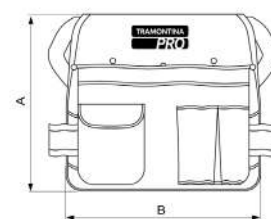

Corpo produzido em nylon de alta resistência
Bolsos para armazenamento e transporte de ferramentas.
Cinto de fixação com engate plástico.
Cinto com regulagem.

Cuerpo fabricado en nylon de alta resistencia
Bolsillos para almacenamiento y transporte de herramientas.
Cinturón de fijación con enganche plástico.
Cinturón ajustable.

Made of highly resistant nylon
Pockets for storing and transporting tools.
Attachment belt with plastic clip.
Adjustable belt.

Aplicações | Aplicación | Application

- Armazenamento e transporte de ferramentas manuais, peças e acessórios.
- Almacenamiento y transporte de herramientas manuales y accesorios.
- Storage and transportation of hand tools and accessories.



REF.	CAP. CAP.	PESO WEIGHT	Medidas Dimensiones Dimensions (mm)		
			A	B	C
44952/520	10 kg	1,50 kg	415	340	190

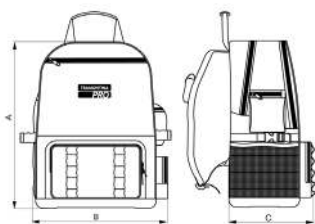

Aplicações | Aplicación | Application

- Armazenamento e transporte de ferramentas manuais, peças e acessórios.
- Almacenamiento y transporte de herramientas manuales y accesorios.
- Storage and transportation of hand tools and accessories.

Mochila para ferramentas

Mochila porta herramientas | Tools back pack



Corpo fabricado em nylon.
Alça de ombro com engates plásticos.
Base com reforço.
Bolsos laterais e compartimento interno fechados por zíper para armazenamento mais seguro das ferramentas.
Tamanho: 20".

Cuerpo fabricado en nylon.
Bandolera con enganche plástico.
Base reforzada.
Bolsillos laterales y compartimento interno con cremallera para un almacenamiento seguro de las herramientas.
Tamaño: 20".

Body made in nylon.
Shoulder strap with plastic hooks.
Bottom injected in PVC.
Side pockets and internal compartment with zipper for safer storage.
Size: 20".



REF.	CAP. CAP.	PESO WEIGHT	Medidas Dimensiones Dimensions (mm)		
			A	B	C
44952/526	15 kg	2,235 g	500	440	170

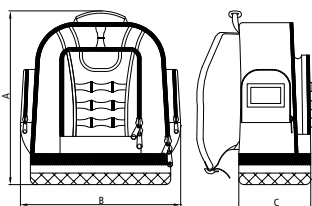

Aplicações | Aplicación | Application

- Armazenamento e transporte de ferramentas manuais, peças e acessórios.
- Almacenamiento y transporte de herramientas manuales y accesorios.
- Storage and transportation of hand tools and accessories.

Mochila para ferramentas

Mochila porta herramientas | Tools back pack



Corpo fabricado em nylon.
Alça de ombro com engates plásticos.
Base injetada em PVC.
Bolsos laterais e compartimento interno fechados por zíper para armazenamento mais seguro das ferramentas.
Tamanho: 25"

Cuerpo fabricado en nylon.
Bandolera con enganche plástico.
Base inyectada en PVC.
Bolsillos laterales y compartimento interno con cremallera para un almacenamiento seguro de las herramientas.
Tamaño: 25"

Body made in nylon.
Shoulder strap with plastic hooks.
Bottom injected in PVC.
Side pockets and internal compartment with zipper for safer storage.
Size: 25"

Mochila para ferramentas

Mochila porta ferramentas | Tools back pack



Corpo fabricado em nylon.
Alça de ombro com engates plásticos.
Base reforçada.

Alça de transporte extensível
Bolsos laterais e compartimento interno fechados por zíper para armazenamento mais seguro das ferramentas.
Tamanho: 25"

Cuerpo fabricado en nylon.
Bandolera con enganche plástico.
Base reforzada.
Mango de transporte extensible.
Bolsillos laterales y compartimento interno con cremallera para un almacenamiento seguro de las herramientas.
Tamaño: 25"

Body made in nylon.
Shoulder strap with plastic hooks.
Reinforced bottom.
Extensible carrying handle.
Side pockets and internal compartment with zipper for safer storage.
Size: 25"

REF.	CAP. CAP.	PESO WEIGHT	Medidas Dimensiones Dimensions (mm)		
			A	B	C
44952/535	15 kg	2,47 kg	540	360	250

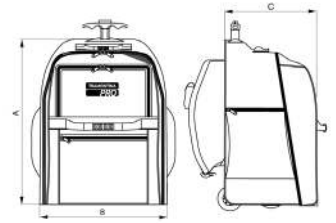

Aplicações | Aplicación | Application

- Armazenamento e transporte de ferramentas manuais, peças e acessórios.
- Almacenamiento y transporte de herramientas manuales y accesorios.
- Storage and transportation of hand tools and accessories.

Bolsa para ferramentas

Bolsa porta ferramentas | Tool bag



Bolsa e alça de ombro fabricados em nylon.
Alça de ombro com engates metálicos gerando maior resistência.
Base injetado em PVC.

Bolsos laterais e compartimento interno fechados por zíper para armazenamento mais seguro das ferramentas.
Tamanho: 12"

Cuerpo y bandolera fabricados en nylon.
Bandolera con enganche metálico para generar una mayor resistencia.
Base inyectada en PVC.
Bolsillos laterales y compartimento interno con cremallera para un almacenamiento seguro de las herramientas.
Tamaño: 12"

Body and shoulder strap made in nylon.
Shoulder strap with metal hooks to generate more resistance.
Bottom injected in PVC.
Side pockets and internal compartment with zipper for safer storage.
Size: 12"

REF.	CAP. CAP.	PESO WEIGHT	Medidas Dimensiones Dimensions (mm)		
			A	B	C
44952/612	10 kg	1,16 kg	220	300	170

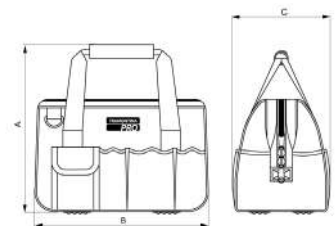

Aplicações | Aplicación | Application

- Armazenamento e transporte de ferramentas manuais, peças e acessórios.
- Almacenamiento y transporte de herramientas manuales y accesorios.
- Storage and transportation of hand tools and accessories.



REF.	CAP. CAP.	PESO WEIGHT	Medidas Dimensiones Dimensions (mm)		
			A	B	C
44952/616	15 kg	1,57 kg	460	420	280

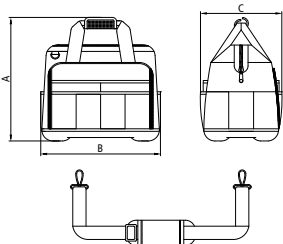

Aplicações | Aplicación | Application

- Armazenamento e transporte de ferramentas manuais, peças e acessórios.
- Almacenamiento y transporte de herramientas manuales y accesorios.
- Storage and transportation of hand tools and accessories.

Bolsa para ferramentas

Bolsa porta herramientas | Tool bag



Bolsa e alça de ombro fabricados em nylon.
Alça de ombro com engates metálicos gerando maior resistência.
Base injetado em PVC.
Bolsos laterais e compartimento interno fechados por zíper para armazenamento mais seguro das ferramentas.
Tamanho: 16"

Cuerpo y bandolera fabricados en nylon.
Bandolera con enganche metálico para generar una mayor resistencia.
Base inyectada en PVC.
Bolsillos laterales y compartimento interno con cremallera para un almacenamiento seguro de las herramientas.
Tamaño: 16"

Body and shoulder strap made in nylon.
Shoulder strap with metal hooks to generate more resistance.
Bottom injected in PVC.
Side pockets and internal compartment with zipper for safer storage.
Size: 16"



REF.	CAP. CAP.	PESO WEIGHT	Medidas Dimensiones Dimensions (mm)		
			A	B	C
44952/622	15 kg	1,95 kg	330	530	300

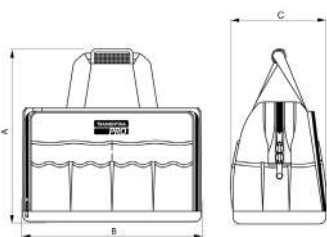

Aplicações | Aplicación | Application

- Armazenamento e transporte de ferramentas manuais, peças e acessórios.
- Almacenamiento y transporte de herramientas manuales y accesorios.
- Storage and transportation of hand tools and accessories.

Bolsa para ferramentas

Bolsa porta herramientas | Tool bag



Bolsa e alça de ombro fabricados em nylon.
Alça de ombro com engates metálicos gerando maior resistência.
Base injetado em PVC.
Bolsos laterais e compartimento interno fechados por zíper para armazenamento mais seguro das ferramentas.
Tamanho: 22"

Cuerpo y bandolera fabricados en nylon.
Bandolera con enganche metálico para generar una mayor resistencia.
Base inyectada en PVC.
Bolsillos laterales y compartimento interno con cremallera para un almacenamiento seguro de las herramientas.
Tamaño: 22"

Body and shoulder strap made in nylon.
Shoulder strap with metal hooks to generate more resistance.
Bottom injected in PVC.
Side pockets and internal compartment with zipper for safer storage.
Size: 22"

Caixa para ferramentas Pickup Box

Caja para herramientas Pickup Box | Pickup box Tool box
820x1000x500 mm



1 PORTA
PUERTA
DOOR

5 GAVETAS
CAJONES
DRAWERS



REF.	PESO WEIGHT	Medidas Dimensiones Dimensions (mm)				
		A	B	C	D	E
44958/007	101,00 kg	1000	500	820	730	880
44958/207	101,00 kg	1000	500	820	730	880
44958/307	101,00 kg	1000	500	820	730	880
44958/407	101,00 kg	1000	500	820	730	880

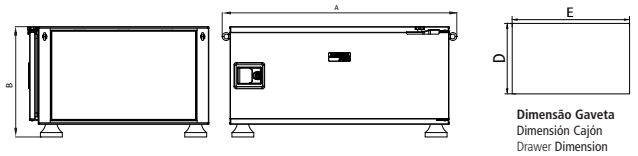

Dimensão Gaveta
Dimensión Cajón
Drawer Dimension

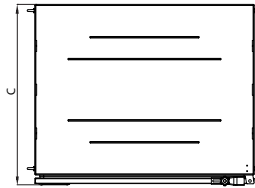

Informações gerais | Informaciones generales | General information:

Cores disponíveis
Colores disponibles
Available colors:



Estrutura em chapas de aço conformadas de 1,2 mm;
5 gavetas com corredeiras telescópicas.
Fechadura reforçada com chave.
Porta com borracha de vedação contra poeira e água.
Pintura eletrostática;
Capacidade de carga máxima gavetas com altura de 50 mm: 30 kg.
Capacidade de carga máxima gavetas com altura de 105 mm: 40 kg.
4 pés com sistema de amortecimento anti vibração (Vibra stop);
Utilizado para o armazenamento de ferramentas e base de trabalho para manutenção de peças.
Capacidade de carga e resistência da estrutura comprovadas através de testes práticos.

Estructura en chapas de acero conformadas de 1,2 mm;
5 cajones con rieles telescópicos.
Cerradura reforzada con llave;
Puerta con goma de obturación contra polvo.
Pintura electrostática;
Capacidad de carga máxima cajones con altura de 50 mm: 30 kg.
Capacidad de carga máxima cajones con altura de 105 mm: 40 kg.
4 pies con sistema de amortiguación anti vibración (Vibra stop);
Utilizado para el almacenamiento de herramientas y base de trabajo para el mantenimiento de piezas.
Capacidad de carga y resistencia de la estructura comprobadas a través de pruebas prácticas.

Body with reinforced structure.
Five drawers with ball bearing slides.
Reinforced lock with key;
Door with rubber sealing against dust;
Electrostatic painting;
Maximum load capacity 50 mm high drawers: 30 kg.
Maximum load capacity drawers with height 105 mm: 40 kg.
4 feet with anti-vibration damping system (Vibra stop);
Used for tool storage and work base for parts maintenance.
Proven load capacity and structure strength through practical tests.



Porta com borracha de vedação contra poeira e água.

Puerta frontal con goma de obturación contra el polvo y agua.

Front door with rubber sealing dust and water.



Fechadura reforçada com chave.

Cierre con llave para las puertas y tirador de plástico.

Doors with key locking system and plastic handle.



Pés para amortecimento de vibração (vibra stop).

4 pies con sistema de amortiguación anti vibración (Vibra stop).

4 feet with anti-vibration damping system (Vibra stop).



4 olhais para fixação da caixa na caminhonete.

4 ojales para fijación de la caja.

4 loops for fixing the box.



Aplicações | Aplicación | Application

- Armazenamento e transporte de ferramentas manuais, peças e acessórios.
- Almacenamiento y transporte de herramientas manuales y accesorios.
- Storage and transportation of hand tools and accessories.



REF.	PESO WEIGHT	Medidas Dimensiones Dimensions (mm)				
		A	B	C	D	E
44958/153	184,00 kg	1000	500	820	730	880

Caixa para ferramentas Pickup Box

Caja para herramientas Pickup Box | Pickup box Tool box
820x1000x500 mm

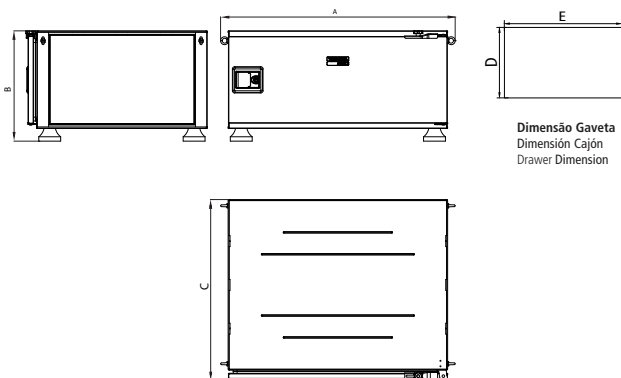

1 PORTA
PUERTA
DOOR

5 GAVETAS
CAJONES
DRAWERS

153 PEÇAS
PIEZAS
PIECES

GAVETA 1 | CAJÓN 1 | DRAWER 1

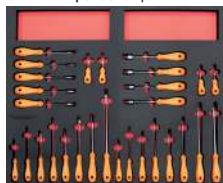

GAVETA 2 | CAJÓN 2 | DRAWER 2



GAVETA 3 | CAJÓN 3 | DRAWER 3



GAVETA 4 | CAJÓN 4 | DRAWER 4

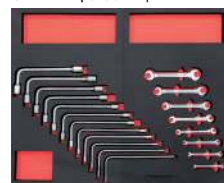

GAVETA 5 | CAJÓN 5 | DRAWER 5



REF.	GAVETA CAJÓN DRAWER	PÇS PZS PCS	CONTEÚDO CONTENIDO SET INCLUDES
44130	1	8	Chaves de fenda ponta chata Destornilladores punta chata Slotted tip screwdrivers: 3x75, 3x125, 5x100, 5x150, 6x100, 6x150, 8x150, 9x250 mm
44132		2	Chaves toco ponta chata Destornilladores corto punta chata Stubby type slotted tip screwdrivers: 5x38, 6x38 mm
44137		8	Chaves de fenda ponta cruzada Destornilladores punta cruzada Cross recessed tipo screwdrivers: (NR. 0) 3x75, 3x125, (NR. 1) 5x100, 5x150, (NR. 2) 6x100, 6x150, (NR. 3) 8x200, (NR. 4) 10x200 mm
44135		2	Chaves toco ponta cruzada Destornilladores corto punta cruzada Stubby type cross recessed tipo screwdrivers: 5x38, 6x38 mm
44251		9	Chaves canhão Destornilladores de tuerca Nut drivers: 6, 7, 8, 9, 10, 11, 12, 13, 14 mm
44745		2	Espátulas chatas Espátula chata Tyre levers: 10", 20"
44033/012		1	Arco de serra regulável Arco de sierra ajustable Adjustable hacksaw: 12"
44042/002		1	Chave para filtro de óleo com cinta Llave para filtro de aceite con cinta Strap oil filter wrench: 40 a 230 mm
44051/108		1	Alicate desencapador de fios automático Pinza pelacable Wire stripper: 8"
44000/108	2	1	Alicate universal isolado 1.000 V Pinza universal aislada 1.000 V 1.000 V insulated combination pliers: 8"
44002/106		1	Alicate corte diagonal isolado 1.000 V Pinza corte diagonal aislada 1.000 V 1.000 V insulated diagonal cutting pliers: 6"
44004/106		1	Alicate meia cana isolado 1.000 V Pinza punta media caña aislada 1.000 V 1.000 V insulated snipe nose pliers: 6"
44004/182		1	Alicate meia cana - Bico longo reto isolado 1.000 V Pinza punta media caña longa aislada 1.000 V Long 1.000 V insulated snipe nose pliers: 8"
44008/107		1	Alicate para anéis interno reto Pinza para anillo interno recto Right internal ring pliers: 7"
44009/107		1	Alicate para anéis interno curvo Pinza para anillo interno curvo Curved internal ring pliers: 7"
44010/107		1	Alicate para anéis externo reto Pinza para anillo externo recto Right external ring pliers: 7"
44011/107		1	Alicate para anéis externo curvo Pinza para anillo externo curvo Curved external ring pliers: 7"
44012/110		1	Alicate de pressão mordente triangular Pinza de presion mordiente triangular Triangular jaw lock pliers: 10"
44660	3	24	Chaves combinadas Llaves combinadas Combination wrenches: 8, 9, 10, 11, 12, 13, 14, 15, 16, 17, 18, 19, 20, 21, 22, 23, 24, 25, 26, 27, 28, 29, 30, 32 mm
44022/112		1	Chave ajustável Llave ajustable Adjustable Wrench: 12"
44610		8	Chaves fixas Llaves fijas Open and wrenches: 6x7, 8x9, 10x11, 12x13, 14x15, 16x17, 18x19, 20x22 mm
44720		12	Chaves biela Llaves de pipa aberta Hollow offset pipe wrenches: 8, 9, 10, 11, 12, 13, 14, 15, 16, 17, 18, 19 mm
44471		4	Saca pinos paralelos Botadores Solid punches: 1.9, 2.8, 4, 5 mm
44473		2	Talhadeiras Cinceles Cold chisels: 15, 19 mm
43156/305		1	Trena Cinta métrica Measuring tape: 5 m
44421/209		1	Jogo de chaves hexagonais longas 9 pçs Juego llaves hexagonales largas 9 pzs 9 pcs long hex keys set: 1.5, 2, 2.5, 3, 4, 5, 6, 8, 10 mm
44450/209		1	Jogo de chaves Hexagonais abauladas 9 pçs Juego de llaves hexagonales 9 pzs 9 pcs hex keys set: 1.5, 2, 2.5, 3, 4, 5, 6, 8, 10 mm
44550/302	5	1	Lanterna de LED recarregável Linterna recargable LED Rechargeable LED flashlight: 10"
43390/302		1	Estilite Profissional Cortadora profesional Professional Knife: 6"
44833		18	Soquetes estriados 1/2" Dados estriados 1/2" 1/2" 12 points sockets: 8, 9, 10, 11, 12, 13, 14, 15, 16, 17, 18, 19, 21, 22, 24, 27, 30, 32 mm
44835/010		1	Cabo T 1/2" Mango T 1/2" 1/2" T handle: 10"
44836		2	Extensões 1/2" Extensiones 1/2" 1/2" Extensions: 5", 10"
44838/101		1	Catraca 1/2" Matraca 1/2" 1/2" Ratchet: 10"
40400/020		1	Junta universal 1/2" Junta universal 1/2" 1/2" universal joint
40440/007		1	Martelo de bola Martillo de bola Ball pein hammer: 500 g - 20 oz
40400/003		1	Martelo de pena Martillo de pena Machinist's hammer: 500 g
40500/003	1	Martelo oitavada Maza octogonal Sledge hammer: 1.500 g - 3 lb	
40670/041	1	Martelo de borda em ABS Martillo de borde em ABS ABS soft faced hammer: 40 mm	
40681/016	1	Martelo borracha Martillo de goma Rubber mallet: 450 g	
44520/120	1	Jogo de lâminas de calibre de folga Juego calibrador de espesores Feeler gauge set: 4"	
44958/007	1	Caixa Pickup box Cajón Pickup box Pickup box	



Caixa para ferramentas Pickup Box

Caja para herramientas Pickup Box | Pickup box Tool box
500x1000x500 mm



REF.	PESO WEIGHT	Medidas Dimensiones Dimensions (mm)				
		A	B	C	D	E
44958/008	66,50 kg	1000	500	500	400	880
44958/208	66,50 kg	1000	500	500	400	880
44958/308	66,50 kg	1000	500	500	400	880
44958/408	66,50 kg	1000	500	500	400	880

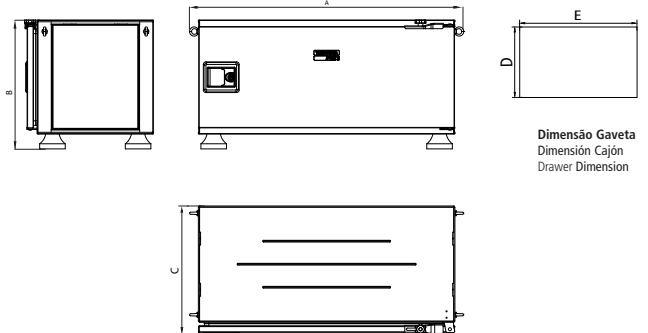

Dimensão Gaveta
Dimensión Cajón
Drawer Dimension

Informações gerais | Informaciones generales | General information:

Estrutura em chapas de aço conformadas de 1,2 mm;
5 gavetas com corrediças telescópicas.
Fechadura reforçada com chave.
Porta com borracha de vedação contra poeira.
Pintura eletrostática;
Capacidade de carga máxima gavetas com altura de 50 mm: 30 kg.
Capacidade de carga máxima gavetas com altura de 105 mm: 40 kg.
4 pés com sistema de amortecimento anti vibração (Vibra stop);
Utilizado para o armazenamento de ferramentas e base de trabalho para manutenção de peças.
Capacidade de carga e resistência da estrutura comprovadas através de testes práticos.

Estructura en chapas de acero conformadas de 1,2 mm;
5 cajones con rieles telescópicos.
Cerradura reforzada con llave;
Puerta con goma de obturación contra polvo.
Pintura electrostática;
Capacidad de carga máxima cajones con altura de 50 mm: 30 kg.
Capacidad de carga máxima cajones con altura de 105 mm: 40 kg.
4 pies con sistema de amortiguación anti vibración (Vibra stop);
Utilizado para el almacenamiento de herramientas y base de trabajo para el mantenimiento de piezas.
Capacidad de carga y resistencia de la estructura comprobadas a través de pruebas prácticas.

Body with reinforced structure.
Five drawers with ball bearing slides.
Reinforced lock with key;
Door with rubber sealing against dust;
Electrostatic painting;
Maximum load capacity 50 mm high drawers: 30 kg.
Maximum load capacity drawers with height 105 mm: 40 kg.
4 feet with anti-vibration damping system (Vibra stop);
Used for tool storage and work base for parts maintenance.
Proven load capacity and structure strength through practical tests.

Cores disponíveis
Colores disponibles
Available colors:



Porta com borracha de vedação contra poeira e água.

Puerta frontal con goma de obturación contra el polvo y agua.

Front door with rubber sealing dust and water.



Fechadura reforçada com chave.

Cierre con llave para las puertas y tirador de plástico.

Doors with key locking system and plastic handle.



Pés para amortecimento de vibração (vibra stop).

4 pies con sistema de amortiguación anti vibración (Vibra stop).

4 feet with anti-vibration damping system (Vibra stop).



4 olhas para fixação da caixa na caminhonete.

4 ojalos para fijación de la caja.

4 loops for fixing the box.



Aplicações | Aplicación | Application

- Armazenamento e transporte de ferramentas manuais, peças e acessórios.
- Almacenamiento y transporte de herramientas manuales y accesorios.
- Storage and transportation of hand tools and accessories.



REF.	PESO WEIGHT	Medidas Dimensiones Dimensions (mm)				
		A	B	C	D	E
44958/145	131,00 kg	1000	500	500	400	880

Caixa para ferramentas Pickup Box

Caja para herramientas Pickup Box | Pickup box Tool box
500x1000x500 mm

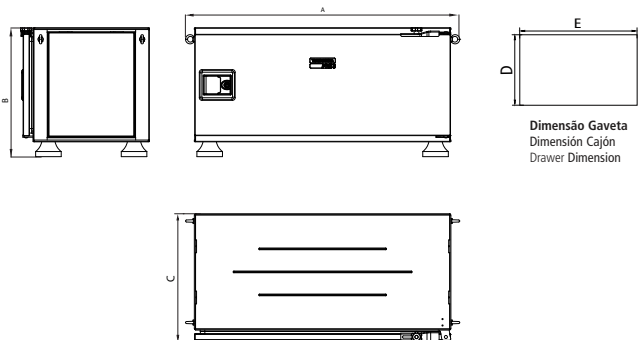

1 PORTA
PUERTA
DOOR

5 GAVETAS
CAJONES
DRAWERS

145 PEÇAS
PIEZAS
PIECES

GAVETA 1 | CAJÓN 1 | DRAWER 1

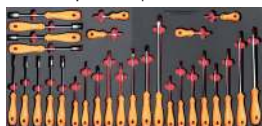

GAVETA 2 | CAJÓN 2 | DRAWER 2



GAVETA 3 | CAJÓN 3 | DRAWER 3

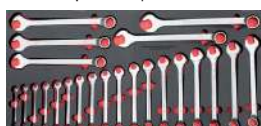

GAVETA 4 | CAJÓN 4 | DRAWER 4



GAVETA 5 | CAJÓN 5 | DRAWER 5



REF.	GAVETA CAJÓN DRAWER	PÇS PZS PCS	CONTEÚDO CONTENIDO SET INCLUDES	
44251	1	9	Chaves canhão Destornilladores de tuerca Nut drivers: 6, 7, 8, 9, 10, 11, 12, 13, 14 mm	
44130		8	Chaves de fenda ponta chata Destornilladores punta chata Slotted tip screwdrivers: 3x75, 3x125, 5x100, 5x150, 6x100, 6x150, 8x150, 9x250 mm	
44132		2	Chaves toco ponta chata Destornilladores corto punta chata Stubby type slotted tip screwdrivers: 5x38, 6x38 mm	
44135		8	Chaves de fenda ponta cruzada Destornilladores punta cruzada Cross recessed tipo screwdrivers: (NR. 0) 3x75, 3x125, (NR. 1) 5x100, 5x150, (NR. 2) 6x100, 6x150, (NR. 3) 8x200, (NR. 4) 10x200 mm	
44137		2	Chaves toco ponta cruzada Destornilladores corto punta cruzada Stubby type cross recessed tipo screwdrivers: 5x38, 6x38 mm	
44000/108	2	1	Alicate universal isolado 1.000 V Pinza universal aislada 1.000 V 1.000 V insulated combination pliers: 8"	
44002/106		1	Alicate corte diagonal isolado 1.000 V Pinza corte diagonal aislada 1.000 V 1.000 V insulated diagonal cutting pliers: 6"	
44004/106		1	Alicate meia cana isolado 1.000 V Pinza punta media caña aislada 1.000 V 1.000 V insulated snipe nose pliers: 6"	
44004/182		1	Alicate meia cana - Bico longo reto isolado 1.000 V Pinza punta media caña longa aislada 1.000 V 1.000 V insulated long snipe nose pliers: 8"	
44008/107		1	Alicate para anéis interno reto Pinza para anillo interno recto Right internal ring pliers: 7"	
44009/107		1	Alicate para anéis interno curvo Pinza para anillo interno curvo Curved internal ring pliers: 7"	
44010/107		1	Alicate para anéis externo reto Pinza para anillo externo recto Right external ring pliers: 7"	
44011/107		1	Alicate para anéis externo curvo Pinza para anillo externo curvo Curved external ring pliers: 7"	
44012/110		1	Alicate de pressão mordente triangular Pinza de presión mordiente triangular Triangular jaw lock pliers: 10"	
44833		18	Soquetes estriados 1/2" Dados estriados 1/2" 1/2" sockets: 8, 9, 10, 11, 12, 13, 14, 15, 16, 17, 18, 19, 21, 22, 24, 27, 30, 32 mm	
44835/010		1	Cabo T 1/2" Mango T 1/2" 1/2" T handle: 10"	
44836		2	Extensões 1/2" Extensiones 1/2" 1/2" Extensions: 5", 10"	
44841/110		1	Catraca 1/2" Matraca 1/2" 1/2" Ratchet: 10"	
44838/101		1	Junta universal 1/2" 1/2" Junta universal 1/2" 1/2" 1/2" 1/2" universal joint 7"	
44660		3	23	Chaves combinadas Llaves combinadas Combination wrenches: 8, 9, 10, 11, 12, 13, 14, 15, 16, 17, 18, 19, 20, 21, 22, 23, 24, 25, 26, 27, 28, 30, 32 mm
44610	4		8	Chaves fixas Llaves fijas Open end wrenches: 6x7, 8x9, 10x11, 12x13, 14x15, 16x17, 18x19, 20x22 mm
44720			12	Chaves biela Llaves de pipa abierta Hollow offset pipe wrenches: 8, 9, 10, 11, 12, 13, 14, 15, 16, 17, 18, 19 mm
44033/012	5		1	Arco de serra regulável Arco de serra regulável Adjustable hacksaw: 12"
44747/060			1	Espátula redonda Espátula redonda Round tyre lever: 24"
44421/209			1	Jogo de chaves hexagonais longas 9 pçs Juego llaves hexagonales largas 9 pzs 9 pcs long hex keys set: 1.5, 2, 2.5, 3, 4, 5, 6, 8, 10 mm
44450/209			1	Jogo de chaves Trafix 9 pçs Juego de llaves Trafix 9 pzs 9 pcs Trafix hex keys set: T10, T15, T20, T25, T27, T30, T40, T45, T50
44460/209			1	Jogo de chaves hexagonais abauladas 9 pçs Juego de llaves hexagonales 9 pzs 9 pcs hex keys set: 1.5, 2, 2.5, 3, 4, 5, 6, 8, 10 mm
44471			4	Saca pinos paralelos Botadores Solid punches: 1.9, 2.8, 4, 5 mm
44473			2	Talhadeiras Cinceles Cold chisels: 15, 19 mm
44042/002		1	Chave para filtro de óleo com cinta Llave para filtro de aceite con cinta Strap oil filter wrench: 40 a 230 mm	
43156/305		1	Trena Cinta métrica Measuring tape: 5 m	
43390/302		1	Estilete Profissional Cortadora profesional Professional Knife: 6"	
40500/002	1	Marreta oitavada Maza octogonal Sledge hammer: 1.000 g - 2 lb		
40440/007	1	Martelo de pena Martillo de pena Machinist's hammer: 500 g		
44520/120	1	Jogo de lâminas de calibre de folga Juego calibrador de espesores Feeler gauge set: 4"		
44958/008	1	Caixa Pickup box Cajón Pickup box Pickup box		

Carro com ferramentas

Carro con herramientas | Tool cabinet

Advantage
SUPER *SALES*



7

GAVETAS
CAJONES
DRAWERS

110

PEÇAS
PIEZAS
PIECES

REF.	PESO WEIGHT	Medidas Dimensiones Dimensions (mm)				
		A	B	C	D	E
44950/110	91,13 kg	1.000	848	460	420	645

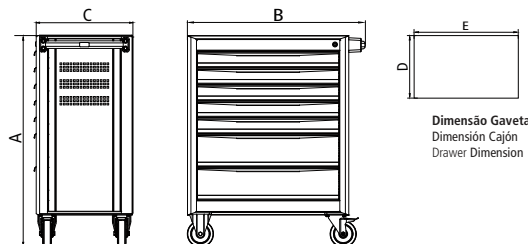

Dimensão Gaveta
Dimensión Cajón
Drawer Dimension



REF.	GAVETA CAJÓN DRAWER	PÇS PZS PCS	CONTEÚDO CONTENIDO SET INCLUDES
44831	1	7	Soquetes sextavados 1/2" Dados sextavados 1/2" 6 points 1/2" sockets: 10, 12, 13, 14, 17, 19, 21 mm
44835/010		1	Cabo T Mango T T handle: 10"
44836		3	Extensões Extensiones Extensions: 3", 5", 10"
44838/001		1	Junta universal 1/2" Junta universal 1/2" 1/2" universal joint
44841/010		1	Catraca reversível Matraca reversible Ratchet: 10"
44885		3	Soquetes de impacto longos 1/2" Dados de impacto longos 1/2" 6 points 1/2" long impact sockets: 17, 19, 21 mm
44828		2	Soquetes sextavados para vela 1/2" Dados sextavados para bujía 1/2" 6 points 1/2" spark plug sockets: 14 mm/9/16", 21 mm/13/16"
44720		8	Chaves biela Llaves de pipa aberta Hollow offset pipe wrenches: 8, 10, 12, 13, 14, 15, 17, 19 mm
44610	2	4	Chaves fixas Llaves fijas Open end wrenches: 10x11, 12x13, 14x15, 17x19 mm
44630		11	Chaves estrela Llaves estriadas Ring spanners: 6x7, 8x9, 10x11, 12x13, 14x15, 17x19, 18x19, 20x22, 21x23, 24x26, 27x32 mm
44675		3	Chaves meia lua Llaves estriadas media luna Obstruction ring wrenches: 11x13, 14x16, 15x17 mm
44000/008	3	1	Alicate universal isolado 1.000 V Pinza universal aislada 1.000 V 1.000 V insulated combination pliers: 8"
44002/006		1	Alicate corte diagonal isolado 1.000 V Pinza corte diagonal aislada 1.000 V 1.000 V insulated diagonal cutting pliers: 6"
44012/010		1	Alicate de pressão mordente triangular Pinza de presión mordiente triangular Triangular jaw lock pliers: 10"
44038/010		1	Alicate bomba d'água isolado 1.000 V Pinza pico loro aislada 1.000 V 1.000 V insulated water pump pliers: 10"
44008/007		1	Alicate para anéis interno reto Pinza para anillo interno recto Right internal ring pliers: 7"
44009/007		1	Alicate para anéis interno curvo Pinza para anillo interno curvo Curved internal ring pliers: 7"
44010/007		1	Alicate para anéis externo reto Pinza para anillo externo recto Right external ring pliers: 7"
44010/070	1	Alicate para anéis ponta chata Pinza para anillo punta recta Straight nose ring pliers: 7"	
44011/007	1	Alicate para anéis externo curvo Pinza para anillo externo curvo Curved external ring pliers: 7"	
44400/209	4	1	Jogo de chaves hexagonais 9 pçs Juego de llaves hexagonales 9 pzs 9 pcs hex keys set: 1,5, 2, 2,5, 3, 4, 5, 6, 8, 10 mm
44451/207		1	Jogo de chaves Trafix 7 pçs Juego de llaves Trafix 7 pzs 7 pcs Trafix keys set: T10, T15, T20, T25, T27, T30, T40
40400/032		1	Martelo de bola Martillo de bola Ball pein hammer: 800 g
40680/080		1	Martelo de borracha Martillo de goma Rubber mallet: 80 mm
44470/006		1	Saca pino cônico botador Solid punch: 6 mm
44471		2	Saca pinos paralelos Botadores Solid punches: 4, 5 mm
44472		2	Punções de centro Centro pontos Center punches: 4, 5 mm
44473	2	Talhadeiras Cinceles Cold chisels: 16, 19 mm	
44130	5	4	Chaves de fenda ponta chata Destornilladores punta chata Slotted tip screwdrivers: 3x100, 6x150, 8x150, 9x200 mm
44132/001		1	Chave toco ponta chata Destornillador corto punta chata Stubby type slotted tip screwdriver: 5x38 mm
44135		3	Chaves de fenda ponta cruzada Destornilladores punta cruzada Cross recessed tip screwdrivers: (Nr.1) 5x125, (Nr.2) 6x150, (Nr.3) 8x150 mm
44137/001		1	Chave toco ponta cruzada Destornillador corto punta cruzada Stubby type cross recessed tipo screwdriver: (Nr.1) 5x38 mm
44250		5	Chaves canhão Destornilladores de tuerca Nut drivers: 6, 7, 8, 10, 12 mm
44660	6	15	Chaves combinadas Llaves combinadas Combination wrenches: 6, 7, 8, 10, 12, 13, 14, 15, 17, 19, 21, 22, 24, 27, 30 mm
44635		2	Chaves poligonais Llaves poligonales abiertas Double end flare nut wrenches: 14x17, 17x19 mm
44520/120		1	Jogo de lâminas de folga 20 pçs Juego calibrador de espesores 20 pzs Feeler gauge set 20 pcs
44950/411	1	Carro para ferramentas Carro para herramientas Tool cabinet	



REF.	PESO WEIGHT	Medidas Dimensiones Dimensions (mm)				
		A	B	C	D	E
44950/135	87,40 kg	1.000	848	460	420	645

Carro com ferramentas
Carro con herramientas | Tool cabinet

Advantage
SUPER SALES

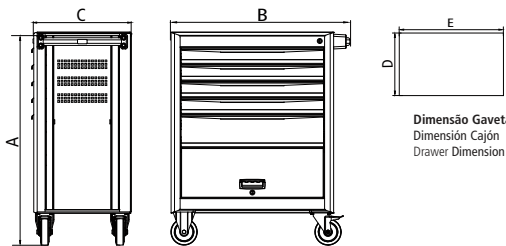

Dimensão Gaveta
Dimensión Cajón
Drawer Dimension

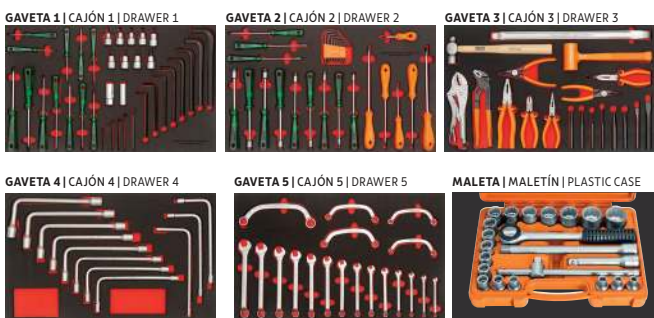

5 GAVETAS
CAJONES
DRAWERS

1 PORTA
PUERTA
DOOR

136 PEÇAS
PIEZAS
PIECES

REF.	GAVETA CAJÓN DRAWER	PÇS PZS PCS	CONTEÚDO CONTENIDO SET INCLUDES
44844		9	Soquetes ponta Trafrix 1/2" Dados punta Trafrix 1/2" 6 points 1/2" Trafrix tip sockets: T20, T25, T27, T30, T40, T45, T50, T55, T60
44350	1	12	Chaves Trafrix com cabo Llave Trafrix con mango Trafrix wrenches with handle: T6, T7, T8, T9, T10, T15, T20, T25, T27, T30, T40, T45
44421/214		1	Jogo de chaves hexagonais longas 14 pçs Juego de llaves hexagonales largas 14 pzs 14 pcs long hex key set: 1,5, 2, 2,5, 3, 4, 5, 6, 7, 8, 9, 10, 11, 12, 14 mm
44828	2	2	Soquetes sextavados para vela 1/2" Dados sextavados para bujía 1/2" 6 points 1/2" spark plug sockets: 16 mm/5/8", 21 mm/13/16"
44130		2	Chaves de fenda ponta chata Destornilladores punta chata Slotted tip screwdrivers: 6x150, 8x200 mm
44135	2	3	Chaves de fenda ponta cruzada Destornilladores punta cruzada Cross recessed tip screwdrivers: (Nr. 1) 5x100 , (Nr. 2) 6x150 , (Nr. 3) 8x200 mm
44137/002		1	Chave toco ponta cruzada Destornillador corto punta cruzada Stubby type cross recessed tip screwdriver: (Nr. 2) 6x38 mm
44250/212	2	1	Jogo de chaves canhão 12 pçs Juego de destornilladores de tuerca 12 pzs 12 pcs nut driver set: 3, 4, 5, 6, 7, 8, 9, 10, 11, 12, 13, 14 mm
44450/209		1	Jogo de chaves Trafrix 9 pçs Juego de llaves Trafrix 9 pzs 9 pcs Trafrix key set: T10, T15, T20, T25, T27, T30, T40, T45, T50
44000/008	3	1	Alicate universal isolado 1.000 V Pinza universal aislada 1.000 V 1.000 V insulated combination pliers: 8"
44002/006		1	Alicate corte diagonal isolado 1.000 V Pinza corte diagonal aislada 1.000 V 1.000 V insulated diagonal cutting pliers: 6"
44004/006	3	1	Alicate meia cana isolado 1.000 V Pinza punta media caña aislada 1.000 V 1.000 V insulated snipe nose pliers: 6"
44004/080		1	Alicate curvo isolado 1.000 V Pinza punta curva aislada 1.000 V 1.000 V insulated curved nose pliers: 8"
44012/010	3	1	Alicate de pressão mordente triangular Pinza de presión mordiente triangular Triangular jaw lock pliers: 10"
44038/010		1	Alicate bomba d'água isolado 1.000 V Pinza pico loro aislada 1.000 V 1.000 V insulated water pump pliers: 10"
44008/007	3	1	Alicate para anéis interno reto Pinza para anillo interno recto Straight internal ring pliers: 7"
44010/007		1	Alicate para anéis externo reto Pinza para anillo externo recto Straight external ring pliers: 7"
40400/012	3	1	Martelo de bola Martillo de bola Ball pein hammer: 300 g - 12 oz
40673/037		1	Martelo sem retrocesso Martillo anti rebote Dead blow hammer: 500 g
44470	4	2	Saca pinos cônicos Botadores Solid punches: 4, 5 mm
44471		2	Saca pinos paralelos Botadores Pin punches: 4, 5 mm
44472	4	2	Punções de centro Centro pontos Center punches: 4, 5 mm
44473		2	Talhadeiras Cinceles Cold chisels: 11, 15 mm
44745/050	4	1	Espátula chata Espátula chata Tyre lever: 500 mm
44720		11	Chaves biela Llaves de pipa aberta Hollow offset pipe wrenches: 8, 10, 11, 12, 13, 14, 15, 16, 17, 18, 19 mm
44660	5	14	Chaves combinadas Llaves combinadas Combination wrenches: 6, 7, 8, 9, 10, 11, 12, 13, 14, 15, 16, 17, 18, 19 mm
44675		5	Chaves meia lua Llaves media luna Obstruction ring wrenches: 10x12, 11x13, 14x16, 15x17, 19x22 mm
44833	6	18	Soquetes estriados 1/2" Dados estriados 1/2" 12 points 1/2" sockets: 8, 9, 10, 11, 12, 13, 14, 15, 16, 17, 18, 19, 21, 22, 24, 27, 30, 32 mm
44835/010		1	Cabo T Mango T T handle: 10"
44836	6	2	Extensões Extensiones Extensions: 5", 10"
44838/001		1	Junta universal 1/2" Junta universal 1/2" 1/2" universal joint
44841/010	6	1	Catraca reversível Matraca reversible Ratchet: 10"
44950/209		1	Maleta plástica Maletín plástico Plastic case
44950/209		1	Carro para ferramentas Carro para herramientas Tool cabinet

Carro com ferramentas

Carro con herramientas | Tool cabinet

Advantage
SUPER *SAFETY*



5

GAVETAS
CAJONES
DRAWERS

1

PORTA
PUERTA
DOOR

95

PEÇAS
PIEZAS
PIECES

REF.	PESO WEIGHT	Medidas Dimensiones Dimensions (mm)				
		A	B	C	D	E
44950/795	82,12 kg	1.000	848	460	420	645

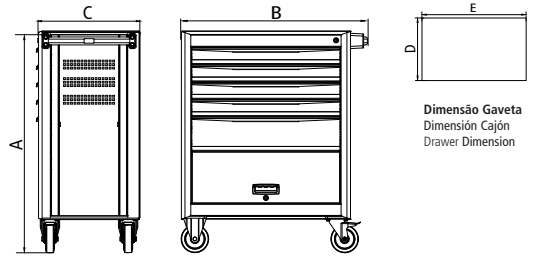

Dimensão Gaveta
Dimensión Cajón
Drawer Dimension

GAVETA 1 | CAJÓN 1 | DRAWER 1



GAVETA 2 | CAJÓN 2 | DRAWER 2



GAVETA 3 | CAJÓN 3 | DRAWER 3



GAVETA 4 | CAJÓN 4 | DRAWER 4



REF.	GAVETA CAJÓN DRAWER	PÇS PZS PCS	CONTEÚDO CONTENIDO SET INCLUDES
44000/008	1	1	Alicate universal isolado 1.000 V Pinza universal aislada 1.000 V 1.000 V insulated combination pliers: 8"
44002/006		1	Alicate corte diagonal isolado 1.000 V Pinza corte diagonal aislada 1.000 V 1.000 V insulated diagonal cutting pliers: 6"
44004/006		1	Alicate meia cana isolado 1.000 V Pinza punta media caña aislada 1.000 V 1.000 V insulated snipe nose pliers: 6"
44008/007		1	Alicate para anéis interno reto Pinza para anillo interno recto Straight internal ring pliers: 7"
44010/007		1	Alicate para anéis externo reto Pinza para anillo externo recto Straight external ring pliers: 7"
44012/010		1	Alicate de pressão mordente triangular Pinza de presión mordiente triangular Triangular jaw lock pliers: 10"
44038/010		1	Alicate bomba d'água isolado 1.000 V Pinza pico loro aislada 1.000 V 1.000 V insulated water pump pliers: 10"
44400/209		1	Jogo de chaves hexagonais 9 pçs Juego de llaves hexagonales 9 pzs 9 pcs hex keys set: 1,5, 2, 2,5, 3, 4, 5, 6, 8, 10 mm
44450/209		1	Jogo de chaves Trafrix 9 pçs Juego de llaves Trafrix 9 pzs 9 pcs Trafrix hex keys: T10, T15, T20, T25, T27, T30, T40, T45, T50
44460/209		1	Jogo de chaves hexagonais abauladas 9 pçs Juego de llaves hexagonales 9 pzs 9 pcs hex keys set: 1,5, 2, 2,5, 3, 4, 5, 6, 8, 10 mm
40440/005	2	1	Martelo de pena Martillo de pena Machinist's hammer: 300 g
40670/031		1	Martelo de borda em ABS Martillo de borde plástico de ABS Soft faced hammer ABS tips: 30 mm
44473/019		1	Talhadeira Cincele Cold chisel: 19 mm
44130		4	Chaves de fenda ponta chata Destornilladores punta chata Slotted tip screwdrivers: 3x150, 5x100, 6x150, 8x250 mm
44132/001		1	Chave toco ponta chata Destornillador corto punta chata Stubby type slotted tip screwdriver: 5x38 mm
44135		4	Chaves de fenda ponta cruzada Destornilladores punta cruzada Cross recessed tip screwdrivers: (Nr. 0) 3x75, (Nr. 1) 5x150, (Nr. 2) 6x150, (Nr. 3) 8x150 mm
44137/002		1	Chave toco ponta cruzada Destornillador corto punta cruzada Stubby type cross recessed tip screwdriver: (Nr. 1) 5x38 mm
44250		5	Chaves canhão Destornilladores de tuerca Nut drivers: 6, 7, 8, 10, 13 mm
44720		6	Chaves biela Llaves de pipa aberta Hollow offset pipe wrenches: 8, 10, 11, 13, 14, 15, 16, 17, 18, 19 mm
44833		18	Soquetes estriados 1/2" Dados estriados 1/2" 12 points 1/2" sockets: 8, 9, 10, 11, 12, 13, 14, 15, 16, 17, 18, 19, 21, 22, 24, 27, 30, 32 mm
44835/010	3	1	Cabo T Mango T T handle: 10"
44836		2	Extensões Extensiones Extensions: 5" e 10"
44838/001		1	Junta universal 1/2" Junta universal 1/2" 1/2" universal joint
44841/010		1	Catraca reversível Matraca reversible Ratchet: 10"
44660	4	15	Chaves combinadas Llaves combinadas Combination wrenches: 6, 7, 8, 10, 11, 12, 13, 14, 17, 19, 22, 24, 27, 30, 32 mm
44950/309		1	Carro para ferramentas Carro para herramientas Tool cabinet



REF.	PESO WEIGHT	Medidas Dimensiones Dimensions (mm)				
		A	B	C	D	E
44950/715	82,20 kg	1.000	848	460	420	645

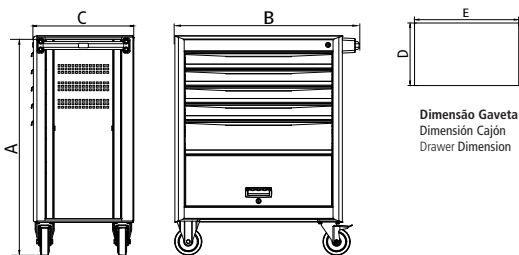

Dimensão Gaveta
Dimensão Cajón
Drawer Dimension

Carro com ferramentas Carro con herramientas | Tool cabinet

Advantage
SUPER *5000*



GAVETA 1 | CAJÓN 1 | DRAWER 1



GAVETA 2 | CAJÓN 2 | DRAWER 2



GAVETA 3 | CAJÓN 3 | DRAWER 3



GAVETA 4 | CAJÓN 4 | DRAWER 4



5 GAVETAS
CAJONES
DRAWERS

1 PORTA
PUERTA
DOOR

115 PEÇAS
PIEZAS
PIECES

REF.	GAVETA CAJÓN DRAWER	PÇS PZS PCS	CONTEÚDO CONTENIDO SET INCLUDES
44660	1	14	Chaves combinadas Llaves combinadas Combination wrenches: 6, 7, 8, 9, 10, 11, 12, 13, 14, 15, 16, 17, 18, 19 mm
44610		10	Chaves fixas Llaves fijas Open end wrenches: 6x7, 8x9, 10x11, 12x13, 14x15, 16x17, 17x19, 18x19, 19x22, 20x22 mm
44831		16	Soquetes sextavados 1/2" Dados sextavados 1/2" 1/2" 6 points sockets: 10, 11, 12, 13, 14, 15, 16, 17, 18, 19, 21, 22, 24, 27, 30, 32 mm
44835/010		1	Cabo T 1/2" Mango T 1/2" 1/2" T handle: 10"
44836		2	Extensões 1/2" Extensiones 1/2" 1/2" Extensions: 5", 10"
44841/010		1	Catraca reversível 1/2" Matraca reversible 1/2" 1/2" Ratchet: 10"
44400/209		1	Jogo de chaves hexagonais 9 pçs Juego de llaves hexagonales 9 pzs 9 pcs hex keys set: 1.5, 2, 2.5, 3, 4, 5, 6, 8, 10 mm
44980/026		3	Bandejas para objetos diversos Módulos para objetos diversos Storage units for several objects
44012/010		1	Alicate de pressão mordente triangular Pinza de presión mordiente triangular Triangular jaw lock pliers: 10"
44110		3	Chaves de fenda ponta chata Destornilladores punta chata Slotted tip screwdrivers: 3x75, 5x100, 6x125 mm
44111/001	1	Chave toco ponta chata Destornillador corto punta chata Stubby type slotted tip screwdriver: 5x38 mm	
44112	3	Chaves de fenda ponta cruzada Destornilladores punta cruzada Cross recessed tip screwdrivers: (Nr. 0) 3x75, (Nr. 1) 5x100, (Nr. 2) 6x150 mm	
44113/001	1	Chave toco ponta cruzada Destornillador corto punta cruzada Stubby type cross recessed tipo screwdriver: (Nr. 1) 5x38 mm	
40440/005	2	1	Martelo de pena Martillo de pena Machinist's hammer: 300 g
40670/031		1	Martelo de bordas em ABS Martillo de borde en ABS ABS soft faced hammer: 30 mm
44470/005		1	Saca pino cônico Botador Solid punch: 5 mm
44471		3	Saca pinos paralelos Botadores Pin punches: 3, 4, 5 mm
44472/004		1	Punção de centro Centro punto Center punch: 4 mm
44473/019	1	Talhadeira Cíncel Cold chisel: 19 mm	
44980/026	3	Bandejas para objetos diversos Módulos para objetos diversos Storage units for several objects	
44022/010	1	Chave ajustável Llave ajustable Adjustable wrench: 10"	
44001/008	3	1	Alicate universal isolado 1.000 V Pinza universal aislada 1.000 V 1.000 V insulated combination pliers: 8"
44003/006		1	Alicate corte diagonal isolado 1.000 V Pinza corte diagonal aislada 1.000 V 1.000 V insulated diagonal cutting pliers: 6"
44005/006		1	Alicate meia cana isolado 1.000 V Pinza media caña aislada 1.000 V 1.000 V insulated snipe nose pliers: 6"
44012/010		1	Alicate de pressão mordente triangular Pinza de presión mordiente triangular Triangular jaw lock pliers: 10"
44400/209		1	Jogo de chaves hexagonais 9 pçs Juego de llaves hexagonales 9 pzs 9 pcs hex keys set: 1.5, 2, 2.5, 3, 4, 5, 6, 8, 10 mm
44420/209		1	Jogo de chaves hexagonais 9 pçs Juego de llaves hexagonales 9 pzs 9 pcs hex keys set: 1/16", 5/64", 3/32", 1/8", 5/32", 3/16", 1/4", 5/16", 3/8"
44450/209		1	Jogo de chaves Trafix 9 pçs Juego de llaves Trafix 9 pzs 9 pcs Trafix hex keys: T10, T15, T20, T25, T27, T30, T40, T45, T50
44460/209		1	Jogo de chaves hexagonais abauladas 9 pçs Juego de llaves hexagonales 9 pzs 9 pcs hex keys set: 1.5, 2, 2.5, 3, 4, 5, 6, 8, 10 mm
44980/026	3	Bandejas para objetos diversos Módulos para objetos diversos Storage units for several objects	
44008	4	2	Alicates para anéis interno reto Pinzas para anillos interno recto Right internal ring pliers: 5.1/2", 7"
44010		2	Alicates para anéis externo reto Pinzas para anillos externo recto Right external ring pliers: 5.1/2", 7"
44980/012		1	Bandeja para objetos diversos Módulo para objetos diversos Storage unit for several objects
44980/014		3	Bandejas para objetos diversos Módulos para objetos diversos Storage units for several objects
44980/026		3	Bandejas para objetos diversos Módulos para objetos diversos Storage units for several objects
44950/009	1	Carro para ferramentas Carro para herramientas Tool cabinet	



Carro com ferramentas Carro con herramientas | Tool cabinet

Advantage
SUPER



7 GAVETAS
CAJONES
DRAWERS

115 PEÇAS
PIEZAS
PIECES

REF.	PESO WEIGHT	Medidas Dimensiones Dimensions (mm)				
		A	B	C	D	E
44950/716	84,20 kg	1.000	848	460	420	645

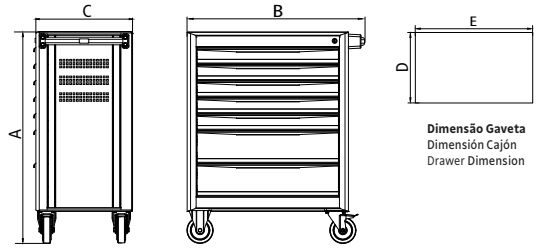

Dimensão Gaveta
Dimensión Cajón
Drawer Dimension

GAVETA 1 | CAJÓN 1 | DRAWER 1



GAVETA 2 | CAJÓN 2 | DRAWER 2



GAVETA 3 | CAJÓN 3 | DRAWER 3



GAVETA 4 | CAJÓN 4 | DRAWER 4



REF.	GAVETA CAJÓN DRAWER	PÇS PZS PCS	CONTEÚDO CONTENIDO SET INCLUDES
44660	1	14	Chaves combinadas Llaves combinadas Combination wrenches: 6, 7, 8, 9, 10, 11, 12, 13, 14, 15, 16, 17, 18, 19 mm
44610		10	Chaves fixas Llaves fijas Open end wrenches: 6x7, 8x9, 10x11, 12x13, 14x15, 16x17, 17x19, 18x19, 19x22, 20x22 mm
44831		16	Soquetes sextavados 1/2" Dados sextavados 1/2" 1/2" 6 points sockets: 10, 11, 12, 13, 14, 15, 16, 17, 18, 19, 21, 22, 24, 27, 30, 32 mm
44835/010		1	Cabo T 1/2" Mango T 1/2" 1/2" T handle: 10"
44836		2	Extensões 1/2" Extensiones 1/2" 1/2" Extensions: 5", 10"
44841/010		1	Catraca reversível 1/2" Matraca reversible 1/2" 1/2" Ratchet: 10"
44400/209		1	Jogo de chaves hexagonais 9 pçs Juego de llaves hexagonales 9 pzs 9 pcs hex keys set: 1.5, 2, 2.5, 3, 4, 5, 6, 8, 10 mm
44980/026		3	Bandejas para objetos diversos Módulos para objetos diversos Storage units for several objects
44012/010		1	Alicate de pressão mordente triangular Pinza de presión mordiente triangular Triangular jaw lock pliers: 10"
44110		3	Chaves de fenda ponta chata Destornilladores punta chata Slotted tip screwdrivers: 3x75, 5x100, 6x125 mm
44111/001	1	Chave toco ponta chata Destornillador corto punta chata Stubby type slotted tip screwdriver: 5x38 mm	
44112	3	Chaves de fenda ponta cruzada Destornilladores punta cruzada Cross recessed tip screwdrivers: (Nr. 0) 3x75, (Nr. 1) 5x100, (Nr. 2) 6x150mm	
44113/001	1	Chave toco ponta cruzada Destornillador corto punta cruzada Stubby type cross recessed tipo screwdriver: (Nr. 1) 5x38 mm	
40440/005	2	1	Martelo de pena Martillo de pena Machinist's hammer: 300 g
40670/031		1	Martelo de bordas em ABS Martillo de borde en ABS ABS soft faced hammer: 30 mm
44470/005		1	Saca pino cônico Botador Solid punch: 5 mm
44471		3	Saca pinos paralelos Botadores Pin punches: 3, 4, 5 mm
44472/004		1	Punção de centro Centro punto Center punch: 4 mm
44473/019	1	Talhadeira Cíncel Cold chisel: 19 mm	
44980/026	3	Bandejas para objetos diversos Módulos para objetos diversos Storage units for several objects	
44022/010	1	Chave ajustável Llave ajustable Adjustable wrench: 10"	
44001/008	3	1	Alicate universal isolado 1.000 V Pinza universal aislada 1.000 V 1.000 V insulated combination pliers: 8"
44003/006		1	Alicate corte diagonal isolado 1.000 V Pinza corte diagonal aislada 1.000 V 1.000 V insulated diagonal cutting pliers: 6"
44005/006		1	Alicate meia cana isolado 1.000 V Pinza media caña aislada 1.000 V 1.000 V insulated snipe nose pliers: 6"
44012/010		1	Alicate de pressão mordente triangular Pinza de presión mordiente triangular Triangular jaw lock pliers: 10"
44400/209		1	Jogo de chaves hexagonais 9 pçs Juego de llaves hexagonales 9 pzs 9 pcs hex keys set: 1.5, 2, 2.5, 3, 4, 5, 6, 8, 10 mm
44420/209		1	Jogo de chaves hexagonais 9 pçs Juego de llaves hexagonales 9 pzs 9 pcs hex keys set: 1/16", 5/64", 3/32", 1/8", 5/32", 3/16", 1/4", 5/16", 3/8"
44450/209		1	Jogo de chaves Trafix 9 pçs Juego de llaves Trafix 9 pzs 9 pcs Trafix hex keys: T10, T15, T20, T25, T27, T30, T40, T45, T50
44460/209		1	Jogo de chaves hexagonais abaúladas 9 pçs Juego de llaves hexagonales 9 pzs 9 pcs hex keys set: 1.5, 2, 2.5, 3, 4, 5, 6, 8, 10 mm
44980/026		3	Bandejas para objetos diversos Módulos para objetos diversos Storage units for several objects
44008		2	Alicates para anéis interno reto Pinzas para anillos interno recto Right internal ring pliers: 5.1/2", 7"
44010	2	Alicates para anéis externo reto Pinzas para anillos externo recto Right external ring pliers: 5.1/2", 7"	
44980/012	4	1	Bandeja para objetos diversos Módulo para objetos diversos Storage unit for several objects
44980/014		3	Bandejas para objetos diversos Módulos para objetos diversos Storage units for several objects
44980/026		3	Bandejas para objetos diversos Módulos para objetos diversos Storage units for several objects
44950/011		1	Carro para ferramentas Carro para herramientas Tool cabinet



Carro com ferramentas Carro con herramientas | Tool cabinet

Advantage
SUPER *Sales*



REF.	PESO WEIGHT	Medidas Dimensiones Dimensions (mm)				
		A	B	C	D	E
44950/717	109,15 kg	1.000	848	460	420	645

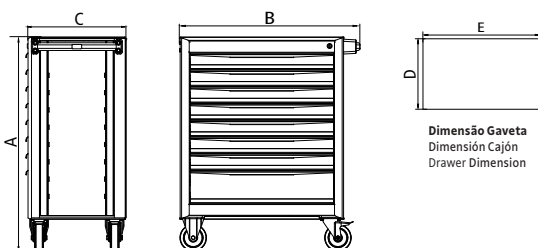

Dimensão Gaveta
Dimensión Cajón
Drawer Dimension

8

GAVETAS
CAJONES
DRAWERS

115

PEÇAS
PIEZAS
PIECES

GAVETA 1 | CAJÓN 1 | DRAWER 1



GAVETA 2 | CAJÓN 2 | DRAWER 2



GAVETA 3 | CAJÓN 3 | DRAWER 3



REF.	GAVETA CAJÓN DRAWER	PÇS PZS PCS	CONTEÚDO CONTENIDO SET INCLUDES
44831	1	16	Soquetes sextavados 1/2" Dados sextavados 1/2" 1/2" 6 points sockets: 10, 11, 12, 13, 14, 15, 16, 17, 18, 19, 21, 22, 24, 27, 30, 32 mm
44835/010		1	Cabo T 1/2" Mango T 1/2" 1/2" T handle: 10"
44836		2	Extensões 1/2" Extensiones 1/2" 1/2" Extensions: 5", 10"
44841/010		1	Catraca reversível 1/2" Matraca reversible 1/2" 1/2" Ratchet: 10"
44110		3	Chaves de fenda ponta chata Destornilladores punta chata Slotted tip screwdrivers: 3x75, 5x100, 6x125 mm
44111/001		1	Chave toco ponta chata Destornillador corto punta chata Stubby type slotted tip screwdriver: 5x38 mm
44112		3	Chaves de fenda ponta cruzada Destornilladores punta cruzada Cross recessed tip screwdrivers: (Nr. 0) 3x75, (Nr. 1) 5x100, (Nr. 2) 6x150 mm
44113/001		1	Chave toco ponta cruzada Destornillador corto punta cruzada Stubby type cross recessed tip screwdriver: (Nr. 1) 5x38 mm
44400/209		2	Jogo de chaves hexagonais 9 pçs Juego de llaves hexagonales 9 pzs 9 pcs hex keys set: 1.5, 2, 2.5, 3, 4, 5, 6, 8, 10 mm
44420/209		1	Jogo de chaves hexagonais 9 pçs Juego de llaves hexagonales 9 pzs 9 pcs hex keys set: 1/16", 5/64", 3/32", 1/8", 5/32", 3/16", 1/4", 5/16", 3/8"
44450/209		1	Jogo de chaves Trafix 9 pçs Juego de llaves Trafix 9 pzs 9 pcs Trafix hex keys: T10, T15, T20, T25, T27, T30, T40, T45, T50
44460/209		1	Jogo de chaves hexagonais abauladas 9 pçs Juego de llaves hexagonales 9 pzs 9 pcs hex keys set: 1.5, 2, 2.5, 3, 4, 5, 6, 8, 10 mm
44022/010		1	Chave ajustável Llave ajustable Adjustable wrench: 10"
44012/010		2	Alicates de pressão mordente triangular Pinzas de presión mordiente triangular Triangular jaw lock pliers: 10"
44001/008		1	Alicate universal isolado 1.000 V Pinza universal aislada 1.000 V 1.000 V insulated combination pliers: 8"
44003/006		1	Alicate corte diagonal isolado 1.000 V Pinza corte diagonal aislada 1.000 V 1.000 V insulated diagonal cutting pliers: 6"
44005/006		1	Alicate meia cana isolado 1.000 V Pinza media caña aislada 1.000 V 1.000 V insulated snipe nose pliers: 6"
44008		2	Alicates para anéis interno reto Pinzas para anillos interno recto Right internal ring pliers: 5.1/2", 7"
44010		2	Alicates para anéis externo reto Pinzas para anillos externo recto Right external ring pliers: 5.1/2", 7"
40440/005		1	Martelo de pena Martillo de pena Machinist's hammer: 300 g
40670/031		1	Martelo de bordas em ABS Martillo de borde en ABS ABS soft faced hammer: 30 mm
44470/005	1	Saca pino cônico Botador Solid punch: 5 mm	
44471	3	Saca pinos paralelos Botadores Pin punches: 3, 4, 5 mm	
44472/004	1	Punção de centro Centro punto Center punch: 4 mm	
44473/019	1	Talhadeira Cíncel Cold chisel: 19 mm	
44660	3	14	Chaves combinadas Llaves combinadas Combination wrenches: 6, 7, 8, 9, 10, 11, 12, 13, 14, 15, 16, 17, 18, 19 mm
44610		10	Chaves fixas Llaves fijas Open end wrenches: 6x7, 8x9, 10x11, 12x13, 14x15, 16x17, 17x19, 18x19, 19x22, 20x22 mm
44950/012		1	Carro para ferramentas Carro para herramientas Tool cabinet

Carro com ferramentas

Carro con herramientas | Tool cabinet

Advantage
Gavetas



5

GAVETAS
CAJONES
DRAWERS

92

PEÇAS
PIEZAS
PIECES

REF.	PESO WEIGHT	Medidas Dimensiones Dimensions (mm)				
		A	B	C	D	E
44950/792	61,11 kg	851	650	460	420	445

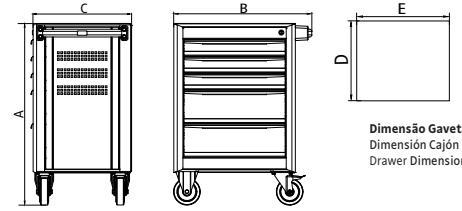

Dimensão Gaveta
Dimensión Cajón
Drawer Dimension

GAVETA 1 | CAJÓN 1 | DRAWER 1



GAVETA 2 | CAJÓN 2 | DRAWER 2



GAVETA 3 | CAJÓN 3 | DRAWER 3



GAVETA 4 | CAJÓN 4 | DRAWER 4



REF.	GAVETA CAJÓN DRAWER	PÇS PZS PCS	CONTEÚDO CONTENIDO SET INCLUDES
44110	1	3	Chaves de fenda ponta chata Destornilladores punta chata Slotted tip screwdrivers: 3x75, 5x100, 6x125 mm
44111/001		1	Chave toco ponta chata Destornillador corto punta chata Stubby type slotted tip screwdriver: 5x38 mm
44112		3	Chaves de fenda ponta cruzada Destornilladores punta cruzada Cross recessed tip screwdrivers: (Nr. 0) 3x75 , (Nr. 1) 5x100 , (Nr. 2) 6x150 mm
44113/001		1	Chave toco ponta cruzada Destornillador corto punta cruzada Stubby type cross recessed tip screwdriver: (Nr. 1) 5x38 mm
44400/209		1	Jogo de chaves hexagonais 9 pçs Juego de llaves hexagonales 9 pzs 9 pcs hex keys set: 1.5, 2, 2.5, 3, 4, 5, 6, 8, 10 mm
44420/209		1	Jogo de chaves hexagonais 9 pçs Juego de llaves hexagonales 9 pzs 9 pcs hex keys set: 1/16", 5/64", 3/32", 1/8", 5/32", 3/16", 1/4", 5/16", 3/8"
44450/209		1	Jogo de chaves Trafix 9 pçs Juego de llaves Trafix 9 pzs 9 pcs Trafix hex keys: T10, T15, T20, T25, T27, T30, T40, T45, T50
44460/209		1	Jogo de chaves hexagonais aauladas 9 pçs Juego de llaves hexagonales 9 pzs 9 pcs hex keys set: 1.5, 2, 2.5, 3, 4, 5, 6, 8, 10 mm
44980/014		2	Bandejas para objetos diversos Módulos para objetos diversos Storage units for several objects
44980/026		2	Bandejas para objetos diversos Módulos para objetos diversos Storage units for several objects
44660	2	14	Chaves combinadas Llaves combinadas Combination wrenches: 6, 7, 8, 9, 10, 11, 12, 13, 14, 15, 16, 17, 18, 19 mm
44831		16	Soquetes sextavados 1/2" Dados sextavados 1/2" 6 points 1/2" sockets: 10, 11, 12, 13, 14, 15, 16, 17, 18, 19, 21, 22, 24, 27, 30, 32 mm
44835/010		1	Cabo T Mango T T handle: 10"
44836		2	Extensões Extensiones Extensions: 5", 10"
44841/010		1	Catraca reversível Matraca reversible Ratchet: 10"
44980/026		2	Bandejas para objetos diversos Módulos para objetos diversos Storage units for several objects
44022/010		1	Chave ajustável Llave ajustable Adjustable wrench: 10"
44001/008		1	Alicate universal isolado 1.000 V Pinza universal aislada 1.000 V 1.000 V insulated combination pliers: 8"
44003/006		1	Alicate corte diagonal isolado 1.000 V Pinza corte diagonal aislada 1.000 V 1.000 V insulated diagonal cutting pliers: 6"
44005/006		1	Alicate meia cana isolado 1.000 V Pinza media caña aislada 1.000 V 1.000 V insulated snipe nose pliers: 6"
44012/010	1	Alicate de pressão mordente triangular Pinza de presión mordiente triangular Triangular jaw lock pliers: 10"	
44980/026	2	Bandejas para objetos diversos Módulos para objetos diversos Storage units for several objects	
44012/010	1	Alicate de pressão mordente triangular Pinza de presión mordiente triangular Triangular jaw lock pliers: 10"	
40440/005	4	1	Martelo de pena Martillo de pena Machinist's hammer: 300 g
40670/031		1	Martelo de borda em ABS Martillo de borde plástico de ABS Soft faced hammer ABS tips: 30 mm
44470/005		1	Saca pino cônico botador Solid punch: 5 mm
44471		3	Saca pino paralelos Botadores Solid punches: 3, 4, 5 mm
44472/004		1	Punção de centro Centro punto Center punch: 4 mm
44473/019		1	Talhadeira Cincele Cold chisel: 19 mm
44980/026		2	Bandejas para objetos diversos Módulos para objetos diversos Storage units for several objects
44950/007		1	Carro para ferramentas Carro para herramientas Tool cabinet



Carro com ferramentas Carro con herramientas | Tool cabinet

Advantage
Sales

REF.	PESO WEIGHT	Medidas Dimensiones Dimensions (mm)				
		A	B	C	D	E
44950/793	64,60 kg	851	650	460	420	445

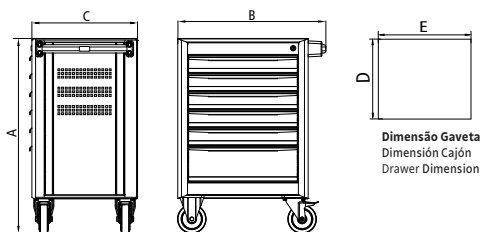

Dimensão Gaveta
Dimensión Cajón
Drawer Dimension



6 GAVETAS
CAJONES
DRAWERS

92 PEÇAS
PIEZAS
PIECES

GAVETA 1 | CAJÓN 1 | DRAWER 1



GAVETA 2 | CAJÓN 2 | DRAWER 2



GAVETA 3 | CAJÓN 3 | DRAWER 3



GAVETA 4 | CAJÓN 4 | DRAWER 4



REF.	GAVETA CAJÓN DRAWER	PCS PZS PCS	CONTEÚDO CONTENIDO SET INCLUDES
44110	1	3	Chaves de fenda ponta chata Destornilladores punta chata Slotted tip screwdrivers: 3x75, 5x100, 6x125 mm
44111/001		1	Chave toco ponta chata Destornillador corto punta chata Stubby type slotted tip screwdriver: 5x38 mm
44112		3	Chaves de fenda ponta cruzada Destornilladores punta cruzada Cross recessed tip screwdrivers: (Nr. 0) 3x75, (Nr. 1) 5x100, (Nr. 2) 6x150 mm
44113/001		1	Chave toco ponta cruzada Destornillador corto punta cruzada Stubby type cross recessed tip screwdriver: (Nr. 1) 5x38 mm
44400/209		1	Jogo de chaves hexagonais 9 pcs Juego de llaves hexagonales 9 pcs 9 pcs hex keys set: 1.5, 2, 2.5, 3, 4, 5, 6, 8, 10 mm
44420/209		1	Jogo de chaves hexagonais 9 pcs Juego de llaves hexagonales 9 pcs 9 pcs hex keys set: 1/16", 5/64", 3/32", 1/8", 5/32", 3/16", 1/4", 5/16", 3/8"
44450/209		1	Jogo de chaves Trafix 9 pcs Juego de llaves Trafix 9 pcs 9 pcs Trafix hex keys: T10, T15, T20, T25, T27, T30, T40, T45, T50
44460/209		1	Jogo de chaves hexagonais abaúladas 9 pcs Juego de llaves hexagonales 9 pcs 9 pcs hex keys set: 1.5, 2, 2.5, 3, 4, 5, 6, 8, 10 mm
44980/014		2	Bandejas para objetos diversos Módulos para objetos diversos Storage units for several objects
44980/026		2	Bandejas para objetos diversos Módulos para objetos diversos Storage units for several objects
44660	2	14	Chaves combinadas Llaves combinadas Combination wrenches: 6, 7, 8, 9, 10, 11, 12, 13, 14, 15, 16, 17, 18, 19 mm
44831		16	Soquetes sextavados 1/2" Dados sextavados 1/2" 6 points 1/2" sockets: 10, 11, 12, 13, 14, 15, 16, 17, 18, 19, 21, 22, 24, 27, 30, 32 mm
44835/010		1	Cabo T Mango T T handle: 10"
44836		2	Extensões Extensiones Extensions: 5", 10"
44841/010		1	Catraca reversível Matraca reversible Ratchet: 10"
44980/026		2	Bandejas para objetos diversos Módulos para objetos diversos Storage units for several objects
44022/010		1	Chave ajustável Llave ajustable Adjustable wrench: 10"
44001/008		1	Alicate universal isolado 1.000 V Pinza universal aislada 1.000 V 1.000 V insulated combination pliers: 8"
44003/006		1	Alicate corte diagonal isolado 1.000 V Pinza corte diagonal aislada 1.000 V 1.000 V insulated diagonal cutting pliers: 6"
44005/006		1	Alicate meia cana isolado 1.000 V Pinza media caña aislada 1.000 V 1.000 V insulated snipe nose pliers: 6"
44012/010	1	Alicate de pressão mordente triangular Pinza de presión mordiente triangular Triangular jaw lock pliers: 10"	
44980/026	2	Bandejas para objetos diversos Módulos para objetos diversos Storage units for several objects	
44012/010	1	Alicate de pressão mordente triangular Pinza de presión mordiente triangular Triangular jaw lock pliers: 10"	
40440/005	1	Martelo de pena Martillo de pena Machinist's hammer: 300 g	
40670/031	1	Martelo de borda em ABS Martillo de borde plástico de ABS Soft faced hammer ABS tips: 30 mm	
44470/005	4	1	Saca pino cônico botador Solid punch: 5 mm
44471		3	Saca pinos paralelos Botadores Solid punches: 3, 4, 5 mm
44472/004		1	Punção de centro Centro punto Center punch: 4 mm
44473/019		1	Talhadeira Cíncel Cold chisel: 19 mm
44980/026		2	Bandejas para objetos diversos Módulos para objetos diversos Storage units for several objects
44950/010	1	Carro para ferramentas Carro para herramientas Tool cabinet	

Carro em inox com ferramentas

Carro en acero inoxidable con herramientas

Stainless steel tool cabinet

REF.	PESO WEIGHT	Medidas Dimensiones Dimensions (mm)				
		A	B	C	D	E
44965/771	81,18 kg	1.000	915	460	400	800

INOX
Series

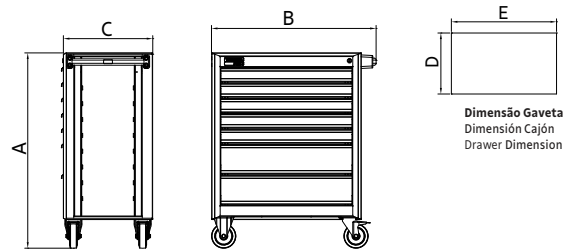

7

GAVETAS
CAJONES
DRAWERS

70

PEÇAS
PIEZAS
PIECES

GAVETA 2 | CAJÓN 2 | DRAWER 2



GAVETA 3 | CAJÓN 3 | DRAWER 3



REF.	GAVETA CAJÓN DRAWER	PÇS PZS PCS	CONTEÚDO CONTENIDO SET INCLUDES	
44660	2	14	Chaves combinadas Llaves combinadas Combination wrenches: 6, 7, 8, 9, 10, 11, 12, 13, 14, 15, 16, 17, 18, 19 mm	
44110		3	Chaves de fenda ponta chata Destornilladores punta chata Slotted tip screwdrivers: 3x75, 5x100, 6x125 mm	
44111/001		1	Chave toco ponta chata Destornillador corto punta chata Stubby type slotted tip screwdriver: 5x38 mm	
44112		3	Chaves de fenda ponta cruzada Destornilladores punta cruzada Cross recessed tip screwdrivers: (Nr. 0) 3x75, (Nr. 1) 5x100, (Nr. 2) 6x150 mm	
44113/001		1	Chave toco ponta cruzada Destornillador corto punta cruzada Stubby type cross recessed tip screwdriver: (Nr. 1) 5x38 mm	
44400/209		1	Jogo de chaves hexagonais 9 pçs Juego de llaves hexagonales 9 pzs 9 pcs hex keys set: 1.5, 2, 2.5, 3, 4, 5, 6, 8, 10 mm	
44420/209		1	Jogo de chaves hexagonais 9 pçs Juego de llaves hexagonales 9 pzs 9 pcs hex keys set: 1/16", 5/64", 3/32", 1/8", 5/32", 3/16", 1/4", 5/16", 3/8"	
44450/209		1	Jogo de chaves Trafix 9 pçs Juego de llaves Trafix 9 pzs 9 pcs Trafix hex keys: T10, T15, T20, T25, T27, T30, T40, T45, T50	
44460/209		1	Jogo de chaves hexagonais abauladas 9 pçs Juego de llaves hexagonales 9 pzs 9 pcs hex keys set: 1.5, 2, 2.5, 3, 4, 5, 6, 8, 10 mm	
44980/014		2	Bandejas para objetos diversos Módulos para objetos diversos Storage units for several objects	
44001/008		3	1	Alicate universal isolado 1.000 V Pinza universal aislada 1.000 V 1.000 V insulated combination pliers: 8"
44003/006			1	Alicate corte diagonal isolado 1.000 V Pinza corte diagonal aislada 1.000 V 1.000 V insulated diagonal cutting pliers: 6"
44005/006			1	Alicate meia cana isolado 1.000 V Pinza media caña aislada 1.000 V 1.000 V insulated snipe nose pliers: 6"
44012/010			1	Alicate de pressão mordente triangular Pinza de presión mordiente triangular Triangular jaw lock pliers: 10"
40440/005	1		Martelo de pena Martillo de pena Machinist's hammer: 300 g	
40670/031	1		Martelo de borda em ABS Martillo de borde plástico de ABS Soft faced hammer ABS tips: 30 mm	
44470/005	1		Saca pino cônico botador Solid punch: 5 mm	
44471	3		Saca pinos paralelos Botadores Solid punches: 3, 4, 5 mm	
44472/004	1		Punção de centro Centro punto Center punch: 4 mm	
44473/019	1		Talhadeira Cíncel Cold chisel: 19 mm	
44980/014	2	Bandejas para objetos diversos Módulos para objetos diversos Storage units for several objects		
44965/001	1	Carro para ferramentas em aço inox Carro para herramientas en acero inoxidable Stainless steel tool cabinet		



REF.	PESO WEIGHT	Medidas Dimensiones Dimensions (mm)		
		A	B	C
44953/017	70,00 kg	1.600	930	230

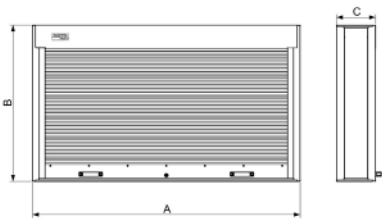

Painel com ferramentas e persiana vertical

Panel con herramientas y persiana vertical

Vertical rolling shutter with tool panel

83

PEÇAS
PIEZAS
PIECES



REF.	PÇS PZS PCS	CONTEÚDO CONTENIDO SET INCLUDES
44130	5	Chaves de fenda ponta chata Destornilladores punta chata Slotted tip screwdrivers: 3x75, 5x100, 6x100, 6x150, 8x150 mm
44135	5	Chaves de fenda ponta cruzada Destornilladores punta cruzada Cross recessed tip screwdrivers: (Nr. 0) 3x75, (Nr. 1) 5x100, (Nr. 2) 6x100, (Nr. 2) 6x150, (Nr. 3) 8x150 mm
44400/209	1	Jogo de chaves hexagonais 9 pçs Juego de llaves hexagonales 9 pzs 9 pcs hex keys set: 1,5, 2, 2,5, 3, 4, 5, 6, 8, 10 mm
44660	12	Chaves combinadas Llaves combinadas Combination wrenches: 6, 7, 8, 10, 11, 12, 13, 14, 17, 19, 22, 24 mm
44831	18	Soquetes sextavados 1/2" Dados hexagonales 1/2" 1/2" 6 points sockets: 8, 9, 10, 11, 12, 13, 14, 15, 16, 17, 18, 19, 21, 22, 24, 27, 30, 32 mm
44835/110	1	Cabo T 10" Mango T T handle: 1/2"
44836	2	Extensões 1/2" Extensiones 1/2" 1/2" Extensions: 5", 10"
44838/101	1	Junta universal 1/2" Junta universal 1/2" 1/2" universal joint
44841/110	1	Catraca 1/2" Matraca reversible 1/2" 1/2" Ratchet: 10"
44720	12	Chaves biela Llaves de pipa abierta Hollow offset pipe wrenches: 8, 9, 10, 11, 12, 13, 14, 15, 16, 17, 18, 19 mm
40400/012	1	Martelo de bola Martillo de bola Ball pein hammer: 300 g
44670/041	1	Martelo de borda ABS Martillo de borde plástico en ABS Soft faced hammer ABS tips: 40 mm
44358	2	Chaves cabo T ponta chata Llaves mango T punta chata Slotted tip T handle: 6x195, 8x210 mm
44359	3	Chaves cabo T ponta cruzada Llaves mango T punta cruzada Cross recessed tip T handle: 5x165, 6x195, 8x290 mm
44012/110	1	Alicate de pressão mordente triangular Pinza de presion mordiente triangular Triangular jaw lock pliers: 10"
44038/110	1	Alicate bomba d'água isolado 1.000 V Pinza pico loro aislada 1.000 V 1.000 V insulated water pump pliers: 10"
44009/107	1	Alicate para anéis internos curvos Pinza para anillo interno curvo Curved internal ring pliers: 7"
44008/107	1	Alicate para anéis internos retos Pinza para anillo interno recto Straight internal ring pliers: 7"
44011/107	1	Alicate para anéis externos curvos Pinza para anillo externo curvo Curved external ring pliers: 7"
44010/107	1	Alicate para anéis externos retos Pinza para anillo externo recto Straight external ring pliers: 7"
44002/106	1	Alicate corte diagonal isolado 1.000 V Pinza corte diagonal aislada 1.000 V 1.000 V insulated diagonal cutting pliers: 6"
44004/106	1	Alicate meia cana isolado 1.000 V Pinza punta media caña aislada 1.000 V 1.000 V insulated snipe nose pliers: 6"
44006/106	1	Alicate bico chato isolado 1.000 V Pinza punta chata aislada 1.000 V 1.000 V insulated flat nose pliers: 6"
44000/108	1	Alicate universal 1.000 V Pinza universal aislada 1.000 V 1.000 V insulated combination pliers: 8"
44953/993	2	Suportes para chaves de fenda Soportes de destornilladores para panel perforado Pegboard screwdriver holder
44953/995	1	Suporte para chaves combinadas Soporte de llaves combinadas para panel perforado Pegboard wrench set holder
44953/996	1	Suporte para jogo de soquetes e acessórios Soporte de dados para panel perforado Pegboard socket and accessories holder
44953/997	1	Suporte para chaves cabo tipo T e tipo L Soporte de llaves pipa para panel perforado Pegboard hollow offset socket wrench holder
44953/999	1	Suporte para alicates Soporte de pinzas para panel perforado Pegboard pliers holder
189570	15	Ganchos avulsos Ganchos sueltos Loose hooks
44953/016	1	Painel sanfonado Panel para herramientas con persiana Rolling shutter tool panel



Caixa com ferramentas

Caja con herramientas | Tool box

5

GAVETAS
CAJONES
DRAWERS

65

PEÇAS
PIEZAS
PIECES2 organizadores em plástico
termoformado para
soquetes e acessórios.2 módulos em plástico para
dados y accesorios.2 plastic storage units for
sockets and accessories.

REF.	PESO WEIGHT	Medidas Dimensiones Dimensions (mm)			
		A	B	C	D
44952/065	15,15 kg	300	525	200	220

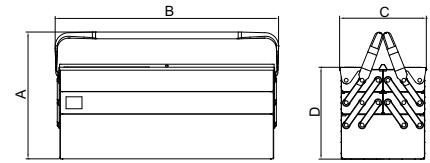

REF.	PCS PZS PCS	CONTEÚDO CONTENIDO SET INCLUDES
44650	11	Chaves combinadas Llaves combinadas Combination wrenches: 6, 8, 9, 10, 11, 12, 13, 14, 17, 19, 22 mm
44022/010	1	Chave ajustável Llave ajustable Adjustable wrench: 10"
44833	18	Soquetes estriados 1/2" Dados estriados 1/2" 12 points 1/2" sockets: 8, 9, 10, 11, 12, 13, 14, 15, 16, 17, 18, 19, 21, 22, 24, 27, 30, 32 mm
44835/010	1	Cabo T Mango T T handle: 10"
44836	2	Extensões Extensiones Extensions: 5", 10"
44837/010	1	Cabo articulado Mago articulado Flex handle: 10"
44838/001	1	Junta universal 1/2" Junta universal 1/2" 1/2" universal joint
44841/010	1	Catraca reversível Matraca reversible Ratchet: 10"
44000/008	1	Alicate universal isolado 1.000 V Pinza universal aislada 1.000 V 1.000 V insulated combination pliers: 8"
44002/006	1	Alicate corte diagonal isolado 1.000 V Pinza corte diagonal aislada 1.000 V 1.000 V insulated diagonal cutting pliers: 6"
44012/010	1	Alicate de pressão mordente triangular Pinza de presión mordiente triangular Triangular jaw lock pliers: 10"
44110	5	Chaves de fenda ponta chata Destornilladores punta chata Slotted tip screwdrivers: 3x75, 5x100, 6x125, 8x150, 9x150 mm
44111/002	1	Chave de fenda toco ponta chata Destornillador corto punta chata Stubby type slotted tip screwdriver: 6x38 mm
44112	4	Chaves de fenda ponta cruzada Destornilladores punta cruzada Cross recessed tip screwdrivers: (Nr. 0) 3x75, (Nr. 1) 5x100, (Nr. 2) 6x150, (Nr. 3) 8x150 mm
44113/002	1	Chave toco ponta cruzada Destornillador corto punta cruzada Stubby type cross recessed tipo screwdriver: (Nr. 2) 6x38 mm
44250	3	Chaves canhão Destornilladores de tuerca Nut drivers: 6, 8, 10 mm
44400/209	1	Jogo de chaves hexagonais 9 pcs Juego de llaves hexagonales 9 pcs 9 pcs hex keys set: 1,5, 2, 2,5, 3, 4, 5, 6, 8, 10 mm
40440/005	1	Martelo de pena Martillo de pena Machinist's hammer: 300 g
40400/020	1	Martelo de bola Martillo de bola Ball pein hammer: 500 g - 18 oz
40671/040	1	Martelo de borda em ABS Martillo de borde plástico de ABS Soft faced hammer ABS tips: 40 mm
44952/000	1	Caixa sanfonada Cargobox Caja porta herramientas Tool box



REF.	PESO WEIGHT	Medidas Dimensiones Dimensions (mm)			
		A	B	C	D
44952/957	10,90 kg	300	525	200	220

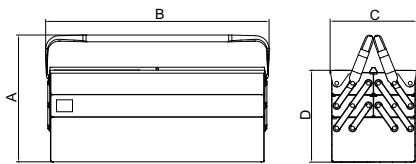

REF.	PÇS PZS PCS	CONTEÚDO CONTENIDO SET INCLUDES
44650	16	Chaves combinadas Llaves combinadas Combination wrenches: 6, 7, 8, 9, 10, 11, 12, 13, 14, 15, 16, 17, 18, 19, 20, 21, 22 mm
44831	20	Soquetes sextavados 1/2" Dados sextavados 1/2" 1/2" 6 points sockets: 8, 9, 10, 11, 12, 13, 14, 15, 16, 17, 18, 19, 20, 21, 22, 23, 24, 27, 30, 32 mm
44838/101	1	Junta universal 1/2" Junta universal 1/2" 1/2" Square drive universal joint
44836/105	1	Extensões Extensiones Extensions: 5"
44835/110	1	Cabo T Mango T T handle: 10"
44841/110	1	Catraca reversível Matraca reversible Ratchet: 8"
44000/108	1	Alicate universal 1.000 V Pinza universal aislada 1.000 V 1.000 V insulated combination pliers: 8"
44002/106	1	Alicate corte diagonal 1.000 V Pinza corte diagonal aislada 1.000 V 1.000 V insulated diagonal cutting plier: 6"
44400/209	1	Jogo de chaves hexagonais 9 pçs Juego de llaves hexagonales 9 pzs 9 pcs hex keys set: 1,5, 2, 2,5, 3, 4, 5, 6, 8, 10 mm
44130	3	Chaves de fenda ponta chata Destornilladores punta chata Slotted tip screwdrivers: 3x100, 5x150, 6x150 mm
44135	3	Chaves de fenda ponta cruzada Destornilladores punta cruzada Cross recessed tip screwdrivers: (Nr. 0) 3x75, (Nr. 1) 5x75, (Nr. 2) 6x100 mm
44952/000	1	Caixa sanfonada Cargobox Caja porta herramientas Tool box

REF.	PESO WEIGHT	Medidas Dimensiones Dimensions (mm)			
		A	B	C	D
44952/635	10,89 kg	395	560	210	218

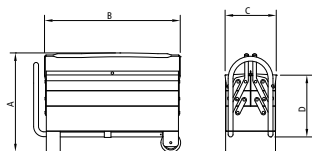

REF.	PÇS PZS PCS	CONTEÚDO CONTENIDO SET INCLUDES
44650	11	Chaves combinadas Llaves combinadas Combination wrenches: 6, 8, 9, 10, 11, 12, 13, 14, 17, 19, 22 mm
44000/008	1	Alicate universal isolado 1.000 V Pinza universal aislada 1.000 V 1.000 V insulated combination pliers: 8"
44002/006	1	Alicate corte diagonal isolado 1.000 V Pinza corte diagonal aislada 1.000 V 1.000 V insulated diagonal cutting pliers: 6"
44012/010	1	Alicate de pressão mordente triangular Pinza de presion mordiente triangular Triangular jaw lock pliers: 10"
44130	3	Chaves de fenda ponta chata Destornilladores punta chata Slotted tip screwdrivers: 3x125, 5x100, 6x125 mm
44132/001	1	Chave de fenda toco ponta chata Destornillador corto punta chata Stubby type slotted tip screwdriver: 5x38 mm
44135	3	Chaves de fenda ponta cruzada Destornilladores punta cruzada Cross recessed tip screwdrivers: (Nr. 0) 3x75, (Nr. 1) 5x100, (Nr. 2) 6x100 mm
44137/001	1	Chave toco ponta cruzada Destornillador corto punta cruzada Stubby type cross recessed tip screwdriver: (Nr. 1) 5x38 mm
44400/209	1	Jogo de chaves hexagonais 9 pçs Juego de llaves hexagonales 9 pzs 9 pcs hex keys set: 1,5, 2, 2,5, 3, 4, 5, 6, 8, 10 mm
44720	4	Chaves biela Llaves de pipa aberta Hollow offset pipe wrenches: 10, 13, 17, 19 mm
44952/600	1	Caixa sanfonada Cargobox Caja porta herramientas Tool box

Caixa com ferramentas Caja con herramientas | Tool box

57

PEÇAS
PIEZAS
PIECES

5

GAVETAS
CAJONES
DRAWERS



Caixa com ferramentas Caja con herramientas | Tool box Composição automotiva | Composición automotriz | Automotive composition

35

PEÇAS
PIEZAS
PIECES

5

GAVETAS
CAJONES
DRAWERS



Caixa sanfonada com ferramentas

Caja con herramientas | Tool box

5

GAVETAS
CAJONES
DRAWERS

60

PEÇAS
PIEZAS
PIECES

2 organizadores em plástico termoforado para soquetes e acessórios.

2 módulos em plástico para dados y accesorios.

2 plastic storage units for sockets and accessories.



REF.	PESO WEIGHT	Medidas Dimensiones Dimensions (mm)			
		A	B	C	D
44952/660	14,37 Kg	395	560	210	218

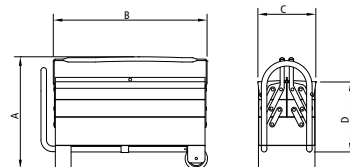

REF.	PÇS PZS PCS	CONTEÚDO CONTENIDO SET INCLUDES
44660	14	Chaves combinadas Llaves combinadas Combination wrenches: 6, 8, 9, 10, 11, 12, 13, 14, 15, 16, 17, 19, 21, 22 mm
44022/010	1	Chave ajustável Llave ajustable Adjustable wrench: 10"
44833	18	Soquetes estriados 1/2" Dados estriados 1/2" 12 points 1/2" sockets: 12, 13, 14, 15, 16, 17, 18, 19, 20, 21, 22, 23, 24, 26, 27, 28, 30, 32 mm
44835/010	1	Cabo T Mango T T handle: 10"
44836	2	Extensões Extensiones Extensions: 5", 10"
44841/010	1	Catraca reversível Matraca reversible Ratchet: 10"
44000/008	1	Alicate universal isolado 1.000 V Pinza universal aislada 1.000 V 1.000 V insulated combination pliers: 8"
44012/010	1	Alicate de pressão mordente triangular Pinza de presión mordiente triangular Triangular jaw lock pliers: 10"
44130	5	Chaves de fenda ponta chata Destornilladores punta chata Slotted tip screwdrivers: 3x75, 5x100, 6x125, 8x150, 9x150 mm
44132/002	1	Chave toco ponta chata Destornillador corto punta chata Stubby type slotted tip screwdriver: 6x38 mm
44135	4	Chaves de fenda ponta cruzada Destornilladores punta cruzada Cross recessed tip screwdrivers: (Nr. 0) 3x75, (Nr. 1) 5x100, (Nr. 2) 6x150, (Nr. 3) 8x150 mm
44137/002	1	Chave toco ponta cruzada Destornillador corto punta cruzada Stubby type cross recessed tipo screwdriver: (Nr. 2) 6x38 mm
44400/209	1	Jogo de chaves hexagonais 9 pçs Juego de llaves hexagonales 9 pzs 9 pcs hex keys set: 1,5, 2, 2,5, 3, 4, 5, 6, 8, 10 mm
40440/005	1	Martelo de pena Martillo de pena Machinist's hammer: 300 g
44952/600	1	Caixa sanfonada Cargobox Caja porta herramientas Tool box



REF.	PESO WEIGHT	Medidas Dimensiones Dimensions (mm)			
		A	B	C	D
44952/665	16,37 Kg	395	560	210	218

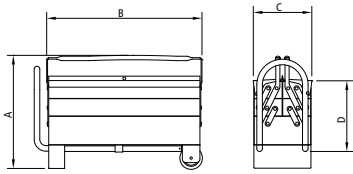

Caixa sanfonada com ferramentas Caja con herramientas | Tool box

5 GAVETAS
CAJONES
DRAWERS



65 PEÇAS
PIEZAS
PIECES

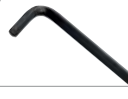

2 organizadores em plástico termoforado para soquetes e acessórios.

2 módulos em plástico para dados y accesorios.

2 plastic storage units for sockets and accessories.



REF.	PÇS PZS PCS	CONTEÚDO CONTENIDO SET INCLUDES
44650	11	Chaves combinadas Llaves combinadas Combination wrenches: 6, 8, 9, 10, 11, 12, 13, 14, 17, 19, 22 mm
44022/010	1	Chave ajustável Llave ajustable Adjustable wrench: 10"
44833	18	Soquetes estriados 1/2" Dados estriados 1/2" 12 points 1/2" sockets: 12, 13, 14, 15, 16, 17, 18, 19, 20, 21, 22, 23, 24, 26, 27, 28, 30, 32 mm
44835/010	1	Cabo T Mango T T handle: 10"
44836	2	Extensões Extensiones Extensions: 5", 10"
44837/010	1	Cabo articulado Mango articulado Flex handle: 10"
44838/001	1	Junta universal 1/2" Junta universal 1/2" 1/2" universal joint
44841/010	1	Catraca reversível Matraca reversible Ratchet: 10"
44000/008	1	Alicate universal isolado 1.000 V Pinza universal aislada 1.000 V 1.000 V insulated combination pliers: 8"
44002/006	1	Alicate corte diagonal isolado 1.000 V Pinza corte diagonal aislada 1.000 V 1.000 V insulated diagonal cutting pliers: 6"
44012/010	1	Alicate de pressão mordente triangular Pinza de presión mordiente triangular Triangular jaw lock pliers: 10"
44110	5	Chaves de fenda ponta chata Destornilladores punta chata Slotted tip screwdrivers: 3x75, 5x100, 6x125, 8x150, 9x150 mm
44111/002	1	Chave de fenda toco ponta chata Destornillador corto punta chata Stubby type slotted tip screwdriver: 6x38 mm
44112	4	Chaves de fenda ponta cruzada Destornilladores punta cruzada Cross recessed tip screwdrivers: (Nr. 0) 3x75, (Nr. 1) 5x100, (Nr. 2) 6x150, (Nr. 3) 8x150 mm
44113/002	1	Chave toco ponta cruzada Destornillador corto punta cruzada Stubby type cross recessed tip screwdriver: (Nr. 2) 6x38 mm
44250	3	Chaves canhão Destornilladores de tuerca Nut drivers: 6, 8, 10 mm
44400/209	1	Jogo de chaves hexagonais 9 pzs Juego de llaves hexagonales 9 pzs 9 pcs hex keys set: 1,5, 2, 2,5, 3, 4, 5, 6, 8, 10 mm
40440/005	1	Martelo de pena Martillo de pena Machinist's hammer: 300 g
40400/020	1	Martelo de bola Martillo de bola Ball pein hammer: 500 g - 18 oz
40671/040	1	Martelo de borda em ABS Martillo de borde plástico de ABS Soft faced hammer ABS tips: 40 mm
44952/600	1	Caixa sanfonada Cargobox Caja porta herramientas Tool box

Caixa em aço inox com ferramentas

Caja con herramientas en acero inoxidable

Stainless steel tool box

65

PEÇAS
PIEZAS
PIECES

5

GAVETAS
CAJONES
DRAWERS

REF.	PESO WEIGHT	Medidas Dimensiones Dimensions (mm)				
		A	B	C	D	E
44952/165	15,43 Kg	305	530	205	240	215

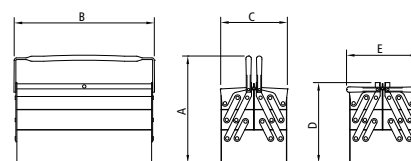

2 organizadores em plástico termoforado para soquetes e acessórios.

2 módulos en plástico para dados y accesorios.

2 plastic storage units for sockets and accessories.

REF.	PÇS PZS PCS	CONTEÚDO CONTENIDO SET INCLUDES
44650	11	Chaves combinadas Llaves combinadas Combination wrenches: 6, 8, 9, 10, 11, 12, 13, 14, 17, 19, 22 mm
44022/010	1	Chave ajustável Llave ajustable Adjustable wrench: 10"
44833	18	Soquetes estriados 1/2" Dados estriados 1/2" 12 points 1/2" sockets: 8, 9, 10, 11, 12, 13, 14, 15, 16, 17, 18, 19, 21, 22, 24, 27, 30, 32 mm
44835/010	1	Cabo T Mango T T handle: 10"
44836	2	Extensões Extensiones Extensions: 5", 10"
44837/010	1	Cabo articulado Mago articulado Flex handle: 10"
44838/001	1	Junta universal 1/2" Junta universal 1/2" 1/2" universal joint
44841/010	1	Catraca reversível Matraca reversible Ratchet: 10"
44000/008	1	Alicate universal isolado 1.000 V Pinza universal aislada 1.000 V 1.000 V insulated combination pliers: 8"
44002/006	1	Alicate corte diagonal isolado 1.000 V Pinza corte diagonal aislada 1.000 V 1.000 V insulated diagonal cutting pliers: 6"
44012/010	1	Alicate de pressão mordente triangular Pinza de presión mordiente triangular Triangular jaw lock pliers: 10"
44110	5	Chaves de fenda ponta chata Destornilladores punta chata Slotted tip screwdrivers: 3x75, 5x100, 6x125, 8x150, 9x150 mm
44111/002	1	Chave de fenda toco ponta chata Destornillador corto punta chata Stubby type slotted tip screwdriver: 6x38 mm
44112	4	Chaves de fenda ponta cruzada Destornilladores punta cruzada Cross recessed tip screwdrivers: (Nr. 0) 3x75, (Nr. 1) 5x100, (Nr. 2) 6x150, (Nr. 3) 8x150 mm
44113/002	1	Chave toco ponta cruzada Destornillador corto punta cruzada Stubby type cross recessed tipo screwdriver: (Nr. 2) 6x38 mm
44250	3	Chaves canhão Destornilladores de tuerca Nut drivers: 6, 8, 10 mm
44400/209	1	Jogo de chaves hexagonais 9 pçs Juego de llaves hexagonales 9 pzs 9 pcs hex keys set: 1,5, 2, 2,5, 3, 4, 5, 6, 8, 10 mm
40440/005	1	Martelo de pena Martillo de pena Machinist's hammer: 300 g
40400/020	1	Martelo de bola Martillo de bola Ball pein hammer: 500 g - 18 oz
40671/040	1	Martelo de borda em ABS Martillo de borde plástico de ABS Soft faced hammer ABS tips: 40 mm
44952/010	1	Caixa sanfonada Cargobox Caja porta herramientas Tool box



Caixa com ferramentas Cargobox Comfort Caja con herramientas Cargobox Comfort Cargobox Comfort tool box

REF.	PESO WEIGHT	Medidas Dimensiones Dimensions (mm)			
		A	B	C	D
44952/760	24,60 kg	404	390	270	390

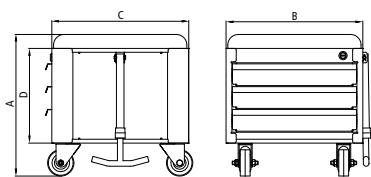

60 PEÇAS
PIEZAS
PIECES

3 GAVETAS
CAJONES
DRAWERS

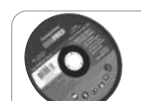

GAVETA 1 | CAJÓN 1 | DRAWER 1



GAVETA 2 | CAJÓN 2 | DRAWER 2



GAVETA 3 | CAJÓN 3 | DRAWER 3



REF.	GAVETA CAJÓN DRAWER	PÇS PZS PCS	CONTEÚDO CONTENIDO SET INCLUDES
44660	1	13	Chaves combinadas Llaves combinadas Combination wrenches: 6, 7, 8, 9, 10, 11, 12, 13, 14, 16, 17, 18, 19 mm
44833	2	15	Soquetes estriados 1/2" Dados estriados 1/2" 12 points 1/2" sockets: 8, 9, 10, 11, 12, 13, 14, 15, 16, 17, 18, 19, 20, 22, 24 mm
44835/010		1	Cabo T Mango T T handle: 10"
44836/005		1	Extensão Extensión Extension: 5"
44841/010		1	Catraca reversível Matraca reversible Ratchet: 10"
44130	3	3	Chaves de fenda ponta chata Destornilladores punta chata Slotted tip screwdrivers: 3x75, 5x100, 6x125 mm
44135		3	Chaves de fenda ponta cruzada Destornilladores punta cruzada Cross recessed tip screwdrivers: (Nr. 0) 3x75, (Nr. 1) 5x100, (Nr. 2) 6x150 mm
44000/008		1	Alicate universal isolado 1.000 V Pinza universal aislada 1.000 V 1.000 V insulated combination pliers: 8"
44002/006	3	1	Alicate corte diagonal isolado 1.000 V Pinza corte diagonal aislada 1.000 V 1.000 V insulated diagonal cutting pliers: 6"
44012/010		1	Alicate de pressão mordente triangular Pinza de presión mordiente triangular Triangular jaw lock pliers: 10"
44400/209	3	1	Jogo de chaves hexagonais 9 pçs Juego de llaves hexagonales 9 pzs 9 pcs hex keys set: 1,5, 2, 2,5,3, 4, 5, 6, 8, 10 mm
44450/209		1	Jogo de chaves Trafrix 9 pçs Juego de llaves Trafrix 9 pzs 9 pcs Trafrix hex keys: T10, T15, T20, T25, T27, T30, T40, T45, T50
40440/005		1	Martelo de pena Martillo de pena Machinist's hammer: 300 g
44550/300		1	Lanterna telescópica Linterna telescópica Telescopic flashlight: 7"
44952/700		1	Caixa Cargobox Comfort Caja Cargobox Comfort Cargobox Comfort tool box

Maleta com ferramentas

Maletín con herramientas | Tool case

70 PEÇAS
PIEZAS
PIECES



REF.	PESO WEIGHT	Medidas Dimensiones Dimensions (mm)		
		A	B	C
44961/070	14,30 kg	609	430	220

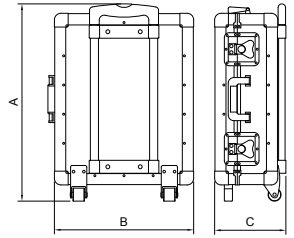

REF.	PÇS PZS PCS	CONTEÚDO CONTENIDO SET INCLUDES
44610/206	1	Jogo de chaves fixas Juego de llaves fijas Open end wrenches set: 6x7, 8x9, 10x11, 12x13, 14x15, 16x17 mm
44022/010	1	Chave ajustável Llave ajustable Adjustable wrench: 10"
44831	8	Soquetes sextavados 1/2" Dados sextavados 1/2" 1/2" 6 points sockets: 10, 16, 20, 21, 23, 26, 28, 30 mm
44841/010	1	Catraca 1/2" Matraca 1/2" 1/2" ratchet: 10"
44000/008	1	Alicate universal isolado 1.000 V Pinza universal aislada 1.000 V 1.000 V insulated combination pliers: 8"
44002/006	1	Alicate corte diagonal isolado 1.000 V Pinza corte diagonal aislada 1.000 V 1.000 V insulated diagonal cutting pliers: 6"
44004/006	1	Alicate meia cana isolado 1.000 V Pinza punta media caña aislada 1.000 V 1.000 V insulated snipe nose pliers: 6"
44012/010	1	Alicate de pressão mordente triangular Pinza de presión mordiente triangular Triangular jaw lock pliers: 10"
44038/010	1	Alicate bomba d'água isolado 1.000 V Pinza pico loro aislada 1.000 V 1.000 V insulated water pump pliers: 10"
44049/009	1	Alicate descascador Pinza pelacable Wire stripper: 9"
44070/001	1	Alicate corte diagonal para eletrônica Pinza corte diagonal para electrónica Diagonal cutting electronic pliers: 4"
44071/001	1	Alicate meia cana para eletrônica Pinza punta media caña para electrónica Snipe nose electronic pliers: 5"
44110	3	Chaves de fenda ponta chata Destornilladores punta chata Slotted tip screwdrivers: 3x150, 5x125, 6x200 mm
44111/001	1	Chave toco ponta chata Destornillador corto punta chata Stubby type slotted tip screwdriver: 5x38 mm
44112	3	Chaves de fenda ponta cruzada Destornilladores punta cruzada Cross recessed tip screwdrivers: (Nr. 0) 3x150, (Nr. 1) 5x150, (Nr. 2) 6x150 mm
44113/001	1	Chave toco ponta cruzada Destornillador corto punta cruzada Stubby type cross recessed tip screwdriver: (Nr.1) 5x38 mm
44115	2	Chaves de fenda ponta chata isoladas 1.000 V Destornilladores punta chata aislados 1.000 V 1.000 V insulated slotted tip screwdrivers: 5x150, 6x150 mm
44116	2	Chaves de fenda ponta cruzada isoladas 1.000 V Destornilladores punta cruzada aislados 1.000 V 1.000 V insulated cross recessed tip screwdrivers: (Nr. 1) 5x150, (Nr. 2) 6x150 mm
41900/010	1	Chave teste Llave teste Voltage tester: 3x75 mm
44250	3	Chaves canhão Destornilladores de tuerca Nut drivers: 6, 8, 13 mm
44400/209	1	Jogo de chaves hexagonais 9 pçs Juego de llaves hexagonales 9 pzs 9 pcs hex keys set: 1,5, 2, 2,5, 3, 4, 5, 6, 8, 10 mm
44420/209	1	Jogo de chaves hexagonais 9 pçs Juego de llaves hexagonales 9 pzs 9 pcs hex keys set: 1/16", 5/64", 3/32", 1/8", 5/32", 3/16", 1/4", 5/16", 3/8"
44450/209	1	Jogo de chaves Trafix 9 pçs Juego de llaves Trafix 9 pzs 9 pcs Trafix hex keys: T10, T15, T20, T25, T27, T30, T40, T45, T50
40440	2	Martelos de pena Martillos de pena Machinist's hammers: 100 g, 300 g
44952/040	1	Maleta para ferramentas com rodinhas e puxador Maletín porta herramientas con ruedas y pujador Tool case with casters and puller



REF.	PESO WEIGHT	Medidas Dimensiones Dimensions (mm)		
		A	B	C
44950/948	15,00 kg	605	400	910
44950/951	14,00 kg	605	400	910

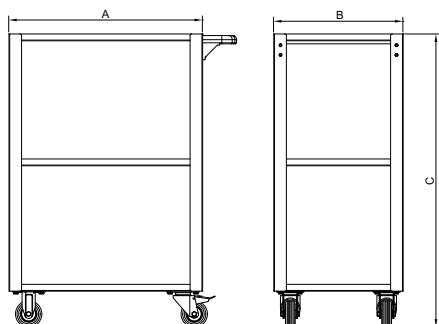

Carro organizador aberto

Carro organizador abierto | Open organizer car



Capacidade estática: 200 kg;
Capacidade dinâmica: 100 - 150 kg.

Capacidad estática: 200 kg;
Capacidad dinámica: 100 - 150 kg.

Static capacity: 200 kg;
Dynamic capacity: 100 - 150 kg.



Informações gerais | Informaciones generales | General information:

Estrutura com paredes reforçadas.

Três bandejas.

Rodas dianteiras fixas em borracha com 80 mm de diâmetro.

Rodas traseiras giratórias em borracha com 80 mm de diâmetro.

Espessura das chapas: 0,9 mm.

Puxador injetado em plástico na cor preta.

Pintura eletrostática na cor preta.

Estructura con paredes reforzadas.

Tres bandejas.

Ruedas delanteras fijas de goma de 80 mm de diámetro.

Ruedas traseras giratorias de goma de 80 mm de diámetro.

Espesor de las chapas: 0,9 mm.

Mango tubular.

Pintura electrostática. en color negro.

Body with reinforced structure.

Three shelves.

Rubber fixed front wheels with diameter of 80 mm.

Rubber swivel rear wheels with diameter of 80 mm.

Sheet thickness: 0.9 mm.

Tubular handle.

Electrostatic painting in Black color.

Aplicações | Aplicación | Application

- Armazenamento e transporte de ferramentas manuais, peças e acessórios.
- Almacenamiento y transporte de herramientas manuales y accesorios.
- Storage and transportation of hand tools and accessories.



Capacidade estática: 150 kg;
Capacidade dinâmica: 80-100 kg
Produto desmontado, embalagem compacta.

Capacidad estática: 150 kg;
Capacidad dinámica: 80-100 kg.
Producto desmontado, embalaje compacto.

Static capacity: 150 kg;
Dynamic capacity: 80-100 kg.
Disassembled, compact packing.



Embalagem compacta | Embalaje compacto | Compact packaging:
820 x 420 x 100 mm

Embalagem compacta - 6 vezes menor que o modelo soldado.
Embalaje compacto - 6 veces menor que el modelo soldado.
Compact packaging - 6 times smaller than the welded model.

Carro para ferramentas

Carro para herramientas | Tool cabinet

REF.	PESO WEIGHT	Medidas Dimensiones Dimensions (mm)				
		A	B	C	D	E
44950/946	58,50 kg	840	570	460	420	445

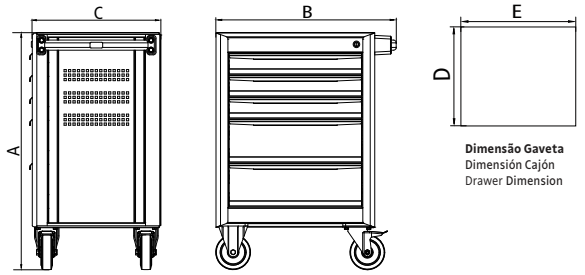

Dimensão Gaveta
Dimensión Cajón
Drawer Dimension



Três gavetas com 75 mm de altura.
Duas gavetas com 154 mm de altura.
Tranca única para todas as gavetas.

Tres cajones de 75 mm de altura.
Dos cajones de 154 mm de altura.
Traba única para todos los cajones.

Three drawers 75 mm high.
Two drawers 154 mm high.
Locking system with key for all drawers.

Aplicações | Aplicación | Application

- Armazenamento e transporte de ferramentas manuais, peças e acessórios.
- Almacenamiento y transporte de herramientas manuales y accesorios.
- Storage and transportation of hand tools and accessories.

Estrutura com paredes reforçadas.
Cinco gavetas com corrediças telescópicas.
Rodas dianteiras fixas de plástico com 125 mm de diâmetro.
Rodas traseiras giratórias de plástico com 125 mm de diâmetro.
Uma roda traseira provida de freio.
Capacidade de carga máxima por gaveta: 30 kg.
Capacidade estática: 300 kg; Capacidade dinâmica: 200 - 250 kg.
Espessuras das chapas: estrutura: 1,2 mm; gavetas: 0,80 mm.
Acompanha puxador ergonômico.
Pintura eletrostática.

Estructura con paredes reforzadas.
Cinco cajones con rieles telescópicos.
Ruedas delanteras fijas de plástico de 125 mm de diámetro.
Ruedas traseras giratorias de plástico de 125 mm de diámetro.
Una rueda trasera con freno.
Capacidad de carga máxima por cajón: 30 kg.
Capacidad estática: 300 kg; Capacidad dinámica: 200 - 250 kg.
Espesor de las chapas: estructura: 1,2 mm; puertas: 0,80 mm.
Tirador ergonómico.
Pintura electrostática.

Body with reinforced structure.
Five drawers with ball bearing slides.
Plastic fixed front wheels with diameter of 125 mm.
Plastic swivel rear wheels with diameter of 125 mm.
One rear wheel equipped with individual brake.
Drawer capacity: 30 kg.
Static capacity: 300 kg; Dynamic capacity: 200 - 250 kg.
Sheet thickness: structure: 1,2 mm; drawers: 0,80 mm.
Rubber cover.
Electrostatic painting.

REF.	PESO WEIGHT	Medidas Dimensiones Dimensions (mm)				
		A	B	C	D	E
44950/949	61,00 kg	840	570	460	420	445

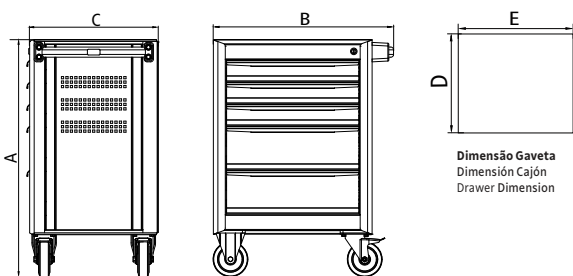

Dimensão Gaveta
Dimensión Cajón
Drawer Dimension

Carro com ferramentas Carro con herramientas | Tool cabinet

45

PEÇAS
PIEZAS
PIECES

5

GAVETAS
CAJONES
DRAWERS

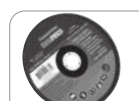

GAVETA 1 | CAJÓN 1 | DRAWER 1



GAVETA 2 | CAJÓN 2 | DRAWER 2



REF.	GAVETA CAJÓN DRAWER	PÇS PZS PCS	CONTEÚDO CONTENIDO SET INCLUDES
44000/008	1	1	Alicate universal isolado 1.000 V Pinza universal aislada 1.000 V 1.000 V insulated combination pliers: 8"
44002/006		1	Alicate corte diagonal isolado 1.000 V Pinza corte diagonal aislada 1.000 V 1.000 V insulated diagonal cutting pliers: 6"
44004/006		1	Alicate meia cana isolado 1.000 V Pinza media caña aislada 1.000 V 1.000 V insulated snipe nose pliers: 6"
44012/010		1	Alicate de pressão mordente triangular Pinza de presión mordiente triangular Triangular jaw lock pliers: 10"
44251		5	Chaves canhão Destornilladores de tuercas sextavadas 6 points nut drives: 6, 7, 8, 10, 11 mm
44400/209	2	1	Jogo de chaves hexagonais 9 peças Juego de llaves hexagonales 9 pzs 9 pcs hex keys set: 1,5, 2, 2,5, 3, 4, 5, 6, 8, 10 mm
44450/209		1	Jogo de chaves Trafix 9 peças Juego de llaves Trafix 9 pzs 9 pcs Trafix hex key: T10, T15, T20, T25, T27, T30, T40, T45, T50
44130		3	Chave de fenda ponta chata Destornilladores punta chata Slotted tip screwdrivers: 3x75, 5x100, 6x125 mm
44135		3	Chave de fenda ponta cruzada Destornilladores punta cruzada Cross recessed tip screwdrivers: 3x75, 5x100, 6x150 mm
44660		12	Chaves combinadas Llaves combinadas Combination wrenches: 6, 7, 8, 10, 11, 12, 13, 14, 15, 17, 18, 19 mm
44950/946	1	Carro para ferramentas Carro para herramientas Tool cabinet	

Bancada simples com 2 pernas e tampo metálico

Bancada sencilla con 2 piernas y tapa metálica

Metal workbench with 2 legs



REF.	PESO WEIGHT	Medidas Dimensiones Dimensions (mm)		
		A	B	C
44950/947	44,00 kg	900	1600	650

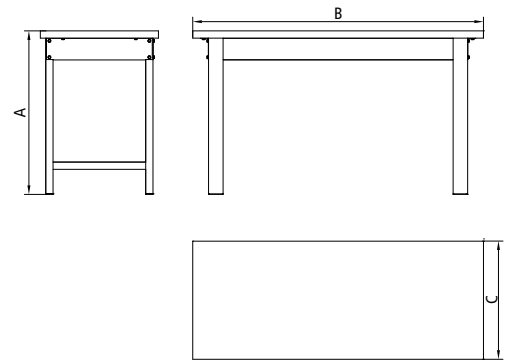

Tampo metálico de 1,6 m com altura de 40 mm.
Estrutura em chapas de aço conformadas.
Capacidade de carga máxima: 250 kg.
Espessura das chapas do tampo: 1,9 mm.
Espessura das chapas da estrutura: 1,2 mm.
Pintura eletrostática na cor preta.

Tapa metálica de 1,6 m con espesor de 40 mm.
Estructura en chapas de acero conformadas.
Capacidad de carga máxima: 250 kg.
Espesor de las chapas de la tapa 1,9 mm.
Espesor de las chapas de la estructura 1,2 mm.
Pintura electrostática em color negro.

1.6 m length metal worktop with 40 mm height.
Conformed steel sheets structure.
Total load capacity: 250 kg.
1.9 mm worktop sheet thickness.
1.2 mm structure sheet thickness.
Electrostatic painting in black color.

Aplicações | Aplicación | Application

- Utilizada como base de trabalho para manutenção de peças.
- Capacidade de carga e resistência da estrutura comprovadas através de testes práticos.
- Acompanha manual de instruções para auxiliar a montagem.
- Utilizada como base de trabajo para mantenimiento de piezas.
- Capacidad de carga y resistencia de la estructura probada con testes prácticos.
- Acompaña manual de instrucciones para ayudar en el montaje.
- Used as work base for tools maintenance.
- Load capacity and structure resistance approved by practical tests.
- Instruction manual included to help assembling process.



SISTEMAS MODULARES TRAMONTINA PRO

Sistemas modulares Tramontina PRO | Tramontina PRO storage system

Os módulos Tramontina PRO, feitos em plástico termoformado, auxiliam em uma melhor racionalização dos espaços, organização e produtividade. Foram projetados para uso nos carros Tramontina PRO.

Los módulos Tramontina PRO, hechos en plástico termoformado, optimizan la utilización de los espacios, organización y productividad. Fueron proyectados para uso en los carros Tramontina PRO.

The Tramontina PRO storage units, made in thermoformed plastic, optimize the spaces, organization and productivity. They were designed to be used on Tramontina PRO cabinets.



Informações importantes para a escolha do módulo de acordo com o tipo de carro (mm):
 Informaciones importantes para la elección del módulo correcto de acuerdo al tipo de carro (mm):
 Important information for choosing the right storage unit, according to the cabinet (mm):

2. TAMANHOS DE MÓDULOS | TAMAÑOS DE LOS MODULOS | STORAGE UNIT SIZES (mm)

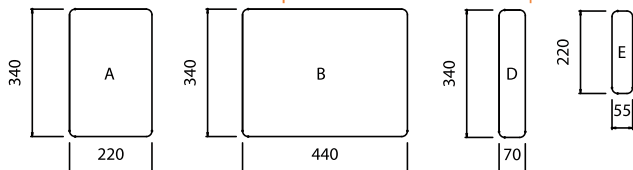

3. COMBINAÇÕES POSSÍVEIS | COMBINACIONES POSIBLES | POSSIBLE COMBINATIONS

ADVANTAGE SUPER SERIES

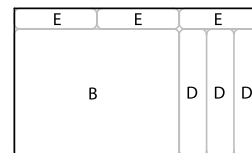
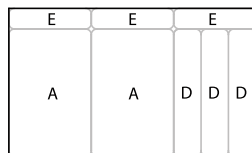
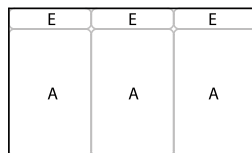
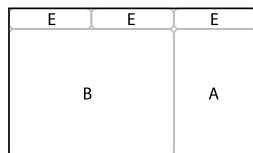

ADVANTAGE SERIES

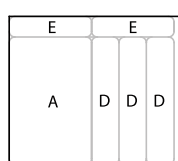
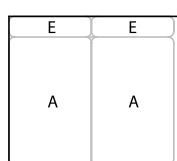
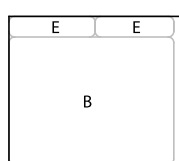

INOX SERIES

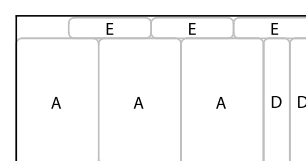
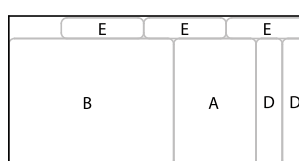

Módulo com chaves combinadas

Módulo con llaves combinadas
Combination wrench module

14 PEÇAS
PIEZAS
PIECES

TAMANHO
TAMAÑO
SIZE

A

Utilização em cada carro |
Utilización en carros |
Use in tool cabinet:



REF.	PESO WEIGHT	Medidas Dimensiones Dimensions (mm)		
		A	B	C
44980/001	1.590 g	340	220	45

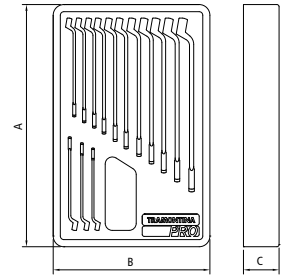

REF.	PÇS PZS PCS	CONTEÚDO CONTENIDO SET INCLUDES
44660	14	Chaves combinadas Llaves combinadas Combination wrenches: 6, 7, 8, 9, 10, 11, 12, 13, 14, 15, 16, 17, 18, 19 mm

Módulo com chaves fixas e hexagonais

Módulo con llaves fijas y hexagonales
Open end wrench and hex key module

19 PEÇAS
PIEZAS
PIECES

TAMANHO
TAMAÑO
SIZE

A

Utilização em cada carro |
Utilización en carros |
Use in tool cabinet:



REF.	PESO WEIGHT	Medidas Dimensiones Dimensions (mm)		
		A	B	C
44980/002	1.650 g	340	220	45

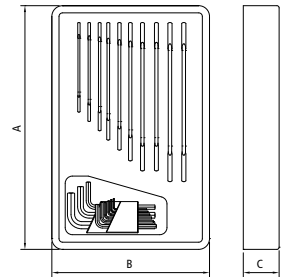

REF.	PÇS PZS PCS	CONTEÚDO CONTENIDO SET INCLUDES
44610	10	Chaves fixas Llaves fijas Open end wrenches: 6x7, 8x9, 10x11, 12x13, 14x15, 16x17, 17x19, 18x19, 19x22, 20x22 mm
44400/209	1	Jogo de chaves hexagonais 9 pçs Juego de llaves hexagonales 9 pzs 9 pcs hex keys set: 1,5, 2, 2,5, 3, 4, 5, 6, 8, 10 mm

Módulo com chaves estrela

Módulo con llaves estriadas | Ring spanner module

8 PEÇAS
PIEZAS
PIECES

TAMANHO
TAMAÑO
SIZE

A

Utilização em cada carro |
Utilización en carros |
Use in tool cabinet:



REF.	PESO WEIGHT	Medidas Dimensiones Dimensions (mm)		
		A	B	C
44980/018	1.720 g	340	220	45

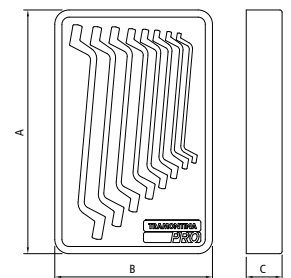

REF.	PÇS PZS PCS	CONTEÚDO CONTENIDO SET INCLUDES
44630	8	Chaves estrela Llaves estriadas Ring spanners: 6x7, 8x9, 10x11, 12x13, 14x15, 16x17, 18x19, 20x22 mm



REF.	PESO WEIGHT	Medidas Dimensiones Dimensions (mm)		
		A	B	C
44980/016	1.010 g	340	220	45

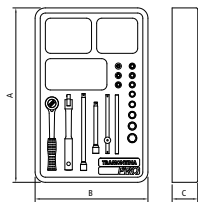

REF.	PÇS PZS PCS	CONTEÚDO CONTENIDO SET INCLUDES
44805	11	Soquetes sextavados 1/4" Dados sextavados 1/4" 6 points 1/4" sockets: 4, 4.5, 5, 5.5, 6, 7, 8, 9, 10, 11, 13 mm
44804/100	1	Catraca reversível Matraca Ratchet: 6"
44804/101	1	Cabo articulado Mango articulado Flexible handle: 6"
44804/102	1	Cabo T Mango T T handle: 4.1/2"
44804/103	1	Manípulo Barra Bar: 4.1/2"
44804	2	Extensões Extensiones Extensions: 4", 6"

REF.	PESO WEIGHT	Medidas Dimensiones Dimensions (mm)		
		A	B	C
44980/017	2.180 g	340	220	45

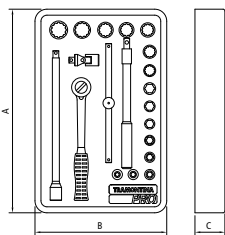

REF.	PÇS PZS PCS	CONTEÚDO CONTENIDO SET INCLUDES
44816	8	Soquetes sextavados 3/8" Dados sextavados 3/8" 6 points 3/8" sockets: 6, 7, 8, 9, 10, 12, 13, 14 mm
44818	7	Soquetes estriados 3/8" Dados estriados 3/8" 12 points 3/8" sockets: 15, 16, 17, 18, 19, 21, 22 mm
44820/008	1	Cabo T Mango T T handle: 8"
44821/010	1	Extensão Extensión Extension: 10"
44822/008	1	Cabo articulado Mango articulado Flexible handle: 8"
44823/001	1	Junta universal 1/2" Junta universal 1/2" 1/2" universal joint
44826/008	1	Catraca Matraca Ratchet: 8"

REF.	PESO WEIGHT	Medidas Dimensiones Dimensions (mm)		
		A	B	C
44980/011	3.560 g	340	220	45

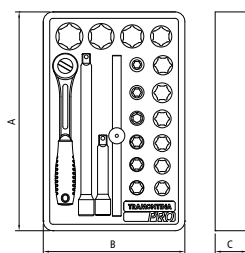

REF.	PÇS PZS PCS	CONTEÚDO CONTENIDO SET INCLUDES
44831	16	Soquetes sextavados 1/2" Dados sextavados 1/2" 6 points 1/2" sockets: 10, 11, 12, 13, 14, 15, 16, 17, 18, 19, 21, 22, 24, 27, 30, 32 mm
44835/010	1	Cabo T Mango T T handle: 10"
44836	2	Extensões Extensiones Extensions: 5", 10"
44841/010	1	Catraca Matraca Ratchet 10"

Módulo com soquetes 1/4"

Módulo con dados 1/4" | 1/4" socket module

17 PEÇAS
PIEZAS
PIECES

TAMANHO
TAMAÑO
SIZE **A**

Utilização em cada carro |
Utilización en carros |
Use in tool cabinet:



Módulo com soquetes 3/8"

Módulo con dados 3/8" | 3/8" socket module

20 PEÇAS
PIEZAS
PIECES

TAMANHO
TAMAÑO
SIZE **A**

Utilização em cada carro |
Utilización en carros |
Use in tool cabinet:



Módulo com soquetes 1/2"

Módulo con dados 1/2" | 1/2" socket module

20 PEÇAS
PIEZAS
PIECES

TAMANHO
TAMAÑO
SIZE **A**

Utilização em cada carro |
Utilización en carros |
Use in tool cabinet:



Módulo com alicates

Módulo com pinças | Pliers module

3

PEÇAS
PIEZAS
PIECES

TAMANHO
TAMAÑO
SIZE

A

Utilização em cada carro |
Utilización en carros |
Use in tool cabinet:



REF.	PESO WEIGHT	Medidas Dimensiones Dimensions (mm)		
		A	B	C
44980/015	1.120 g	340	220	45

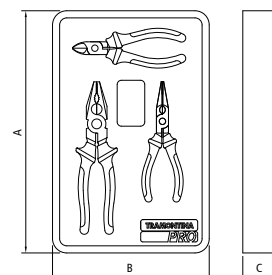

REF.	PÇS PZS PCS	CONTEÚDO CONTENIDO SET INCLUDES
44001/008	1	Alicate universal isolado 1.000 V Pinza universal aislada 1.000 V 1.000 V insulated combination pliers: 8"
44003/006	1	Alicate corte diagonal isolado 1.000 V Pinza corte diagonal aislada 1.000 V 1.000 V insulated diagonal cutting pliers: 6"
44005/006	1	Alicate meia cana isolado 1.000 V Pinza media caña aislada 1.000 V 1.000 V insulated snipe nose pliers: 6"

Módulo com alicates para anéis

Módulo com pinças para anillos | Ring pliers module

4

PEÇAS
PIEZAS
PIECES

TAMANHO
TAMAÑO
SIZE

A

Utilização em cada carro |
Utilización en carros |
Use in tool cabinet:



REF.	PESO WEIGHT	Medidas Dimensiones Dimensions (mm)		
		A	B	C
44980/007	900 g	340	220	45

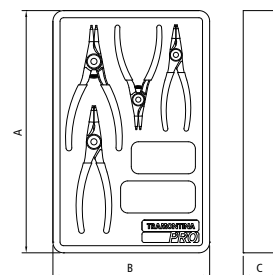

REF.	PÇS PZS PCS	CONTEÚDO CONTENIDO SET INCLUDES
44008	2	Alicates para anéis interno reto Pinzas para anillo interno recto Right internal ring pliers: 5", 7"
44010	2	Alicates para anéis externo reto Pinzas para anillo externo recto Right external ring pliers: 5", 7"

Módulo com alicates

Módulo com pinças | Pliers module

5

PEÇAS
PIEZAS
PIECES

TAMANHO
TAMAÑO
SIZE

B

Utilização em cada carro |
Utilización en carros |
Use in tool cabinet:



REF.	PESO WEIGHT	Medidas Dimensiones Dimensions (mm)		
		A	B	C
44980/009	2.400 g	340	440	45

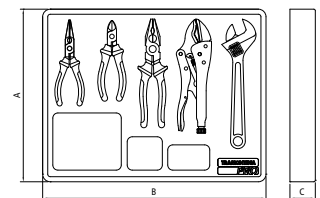

REF.	PÇS PZS PCS	CONTEÚDO CONTENIDO SET INCLUDES
44022/010	1	Chave ajustável Llave ajustable Adjustable wrench: 10"
44012/010	1	Alicate de pressão mordente triangular Pinza de presión mordiente triangular Triangular jaw lock pliers: 10"
44001/008	1	Alicate universal isolado 1.000 V Pinza universal aislada 1.000 V 1.000 V insulated combination pliers: 8"
44003/006	1	Alicate corte diagonal isolado 1.000 V Pinza corte diagonal aislada 1.000 V 1.000 V insulated diagonal cutting pliers: 6"
44005/006	1	Alicate meia cana isolado 1.000 V Pinza media caña aislada 1.000 V 1.000 V insulated snipe nose pliers: 6"



REF.	PESO WEIGHT	Medidas Dimensiones Dimensions (mm)		
		A	B	C
44980/005	800 g	340	220	45

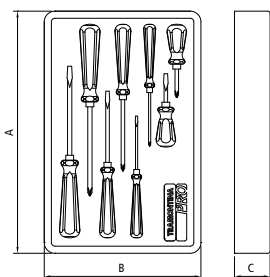

8 PEÇAS
PIEZAS
PIECES

TAMANHO
TAMAÑO
SIZE **A**

Utilização em cada carro |
Utilización en carros |
Use in tool cabinet:

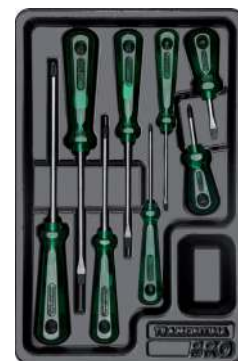

REF.	PÇS PZS PCS	CONTEÚDO CONTENIDO SET INCLUDES
44110	3	Chaves de fenda ponta chata Destornilladores ponta chata Slotted tip screwdrivers: 3x75 mm, 5x100 mm, 6x125 mm
44111/001	1	Chave de fenda toco ponta chata Destornillador corto ponta chata Stubby type slotted tip screwdriver: 5x38 mm
44112	3	Chaves de fenda ponta cruzada Destornillador ponta cruzada Cross recessed tip screwdrivers: (Nr. 0) 3x75, (Nr. 1) 5x100, (Nr. 2) 6x150 mm
44113/001	1	Chave de fenda toco ponta cruzada Destornillador corto ponta cruzada Stubby type cross recessed tip screwdriver: (Nr. 1) 5x38 mm

REF.	PESO WEIGHT	Medidas Dimensiones Dimensions (mm)		
		A	B	C
44980/006	700 g	340	220	45

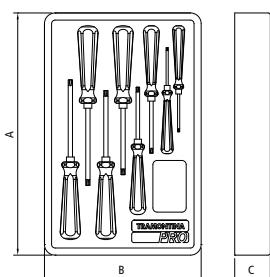

8 PEÇAS
PIEZAS
PIECES

TAMANHO
TAMAÑO
SIZE **A**

Utilização em cada carro |
Utilización en carros |
Use in tool cabinet:



REF.	PÇS PZS PCS	CONTEÚDO CONTENIDO SET INCLUDES
44350	8	Chaves Trafix com cabo Llaves Trafix con mango Trafix wrenches with handle: T6, T7, T8, T10, T15, T20, T25, T30

REF.	PESO WEIGHT	Medidas Dimensiones Dimensions (mm)		
		A	B	C
44980/025	1.950 g	340	440	45

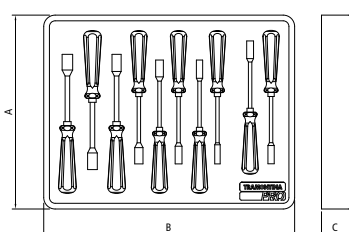

10 PEÇAS
PIEZAS
PIECES

TAMANHO
TAMAÑO
SIZE **B**

Utilização em cada carro |
Utilización en carros |
Use in tool cabinet:



REF.	PÇS PZS PCS	CONTEÚDO CONTENIDO SET INCLUDES
44250	8	Chaves canhão Destornilladores de tuerca Nut drivers: 6, 7, 8, 9, 10, 11, 12, 13 mm
44260	2	Chaves canhão Destornilladores de tuerca Nut drivers: 1/4" x 125 mm, 5/16" x 125 mm



Módulo com ferramentas para manutenção

Módulo con herramientas para mantenimiento

Maintenance tools module

4

PEÇAS
PIEZAS
PIECESTAMANHO
TAMAÑO
SIZE

B

Utilização em cada carro |
Utilización en carros |
Use in tool cabinet:

REF.	PESO WEIGHT	Medidas Dimensiones Dimensions (mm)		
		A	B	C
44980/008	2.360 g	340	440	45

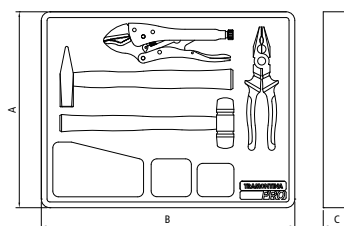

REF.	PÇS PZS PCS	CONTEÚDO CONTENIDO SET INCLUDES
44001/008	1	Alicate universal isolado 1.000 V Pinza universal aislada 1.000 V 1.000 V insulated combination pliers: 8"
44012/010	1	Alicate de pressão mordente triangular Pinza de presión mordiente triangular Triangular jaw lock pliers: 10"
40440/005	1	Martelo de pena Martillo de pena Machinist's hammer: 300 g
40670/031	1	Martelo de borda em ABS Martillo de borde plástico de ABS Soft faced hammer ABS tips: 30 mm

Módulo com ferramentas

Módulo con herramientas | Tools module

9

PEÇAS
PIEZAS
PIECESTAMANHO
TAMAÑO
SIZE

B

Utilização em cada carro |
Utilización en carros |
Use in tool cabinet:

REF.	PESO WEIGHT	Medidas Dimensiones Dimensions (mm)		
A	B	C		
44980/010	2.560 g	340	440	45

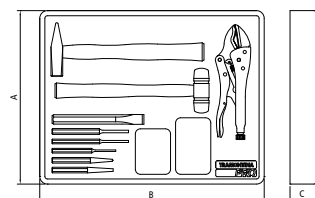

REF.	PÇS PZS PCS	CONTEÚDO CONTENIDO SET INCLUDES
44012/010	1	Alicate de pressão mordente triangular Triangular jaw lock pliers: 10"
40440/005	1	Martelo de pena Martillo de pena Machinist's hammer: 300 g
40670/031	1	Martelo de borda em ABS Martillo de borde plástico de ABS Soft faced hammer ABS tips: 30 mm
44470/005	1	Saca pino cônico botador Solid punch: 5 mm
44471	3	Saca pino paralelo botador Solid punch: 2,8 , 4, 5 mm
44472/004	1	Punções de centro Centro puntos Center punches: 4 mm
44473/019	1	Talhadeira Cinceal Cold chisel: 19 mm.

Módulo com chaves tipo L

Módulo con llaves hexagonales | L key module

36

PEÇAS
PIEZAS
PIECESTAMANHO
TAMAÑO
SIZE

A

Utilização em cada carro |
Utilización en carros |
Use in tool cabinet:

REF.	PESO WEIGHT	Medidas Dimensiones Dimensions (mm)		
A	B	C		
44980/024	1.410 g	340	220	45

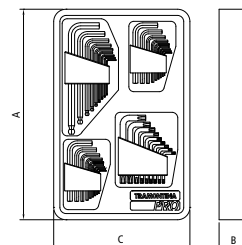

REF.	PÇS PZS PCS	CONTEÚDO CONTENIDO SET INCLUDES
44400/209	1	Jogo de chaves hexagonais 9 pçs Juego de llaves hexagonales 9 pzs 9 pcs hex keys set: 1,5, 2, 2,5, 3, 4, 5, 6, 8, 10 mm
44420/209	1	Jogo de chaves hexagonais 9 pçs Juego de llaves hexagonales 9 pzs 9 pcs hex keys set: 1/16", 5/64", 3/32", 1/8", 5/32", 3/16", 1/4", 5/16", 3/8"
44450/209	1	Jogo de chaves Trafix 9 pçs Juego de llaves Trafix 9 pzs 9 pcs Trafix hex keys: T10, T15, T20, T25, T27, T30, T40, T45, T50
44460/209	1	Jogo de chaves hexagonais 9 pçs Juego de llaves hexagonales 9 pzs 9 pcs hex keys set: 1,5, 2, 2,5, 3, 4, 5, 6, 8, 10 mm



REF.	PESO WEIGHT	Medidas Dimensiones Dimensions (mm)		
		A	B	C
44980/021	2.840 g	340	440	45

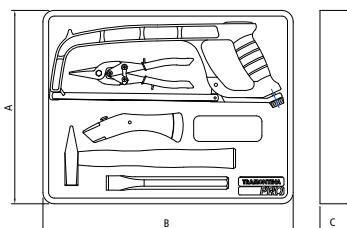

REF.	PÇS PZS PCS	CONTEÚDO CONTENIDO SET INCLUDES
40440/005	1	Martelo de pena Martillo de pena Machinist's hammer: 300 g
44473/025	1	Talhadeira Cíncel Cold chisel: 25 mm.
44023/001	1	Tesoura de aviação - corte reto Tijera de aviación - corte recto Aviation snips - straight cut
44032/012	1	Arco de serra Arco de sierra Hacksaw: 12"
44033/001	1	Faca industrial Cuchillo industrial Industrial knife

Módulo com ferramentas Módulo con herramientas | Tool module



5 PEÇAS
PIEZAS
PIECES

TAMANHO
TAMAÑO
SIZE **B**

Utilização em cada carro |
Utilización en carros |
Use in tool cabinet.

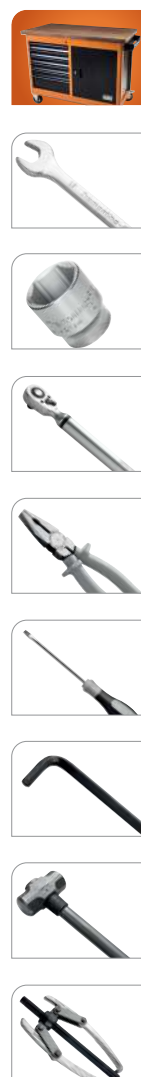

REF.	PESO WEIGHT	Medidas Dimensiones Dimensions (mm)		
		A	B	C
44980/023	4.720 g	340	440	45

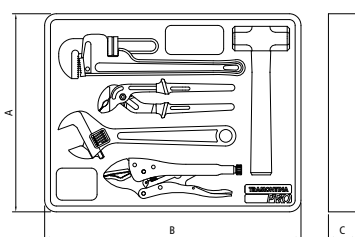

REF.	PÇS PZS PCS	CONTEÚDO CONTENIDO SET INCLUDES
44021/014	1	Chave para tubos - modelo americano Llave para tubos - modelo americano Pipe wrench - american type: 14"
44022/012	1	Chave ajustável Llave ajustable Adjustable wrench: 12"
44012/010	1	Alicate de pressão mordente triangular Pinza de presión mordiente triangular Triangular jaw lock pliers: 10"
44038/010	1	Alicate bomba d'água isolado 1.000 V Pinza pico loro aislada 1.000 V 1.000 V isolated water pump pliers: 10"
40500/002	1	Marreta oitavada Maza octogonal Sledge hammer: 1.000 g - 2 lb

Módulo com ferramentas Módulo con herramientas | Tool module



5 PEÇAS
PIEZAS
PIECES

TAMANHO
TAMAÑO
SIZE **B**

Utilização em cada carro |
Utilización en carros |
Use in tool cabinet.



Módulo com rebitorador e 70 rebites

Módulo com remachadora y 70 remaches | Riveter and 70 rivets module

71 PEÇAS
PIEZAS
PIECES

TAMANHO
TAMAÑO
SIZE **A**

Utilização em cada carro |
Utilización en carros |
Use in tool cabinet:



REF.	PESO WEIGHT	Medidas Dimensiones Dimensions (mm)		
		A	B	C
44980/022	970 g	340	220	45

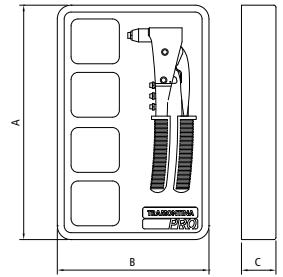

REF.	PÇS PZS PCS	CONTEÚDO CONTENIDO SET INCLUDES
44024/011	1	Rebitorador Remachadora Hand riveter: 10".
	70	Rebites Remaches Rivets

Módulo com chaves biela

Módulo con llaves de pipa abierta | Hollow offset pipe wrench module

7 PEÇAS
PIEZAS
PIECES

TAMANHO
TAMAÑO
SIZE **B**

Utilização em cada carro |
Utilización en carros |
Use in tool cabinet:



REF.	PESO WEIGHT	Medidas Dimensiones Dimensions (mm)		
		A	B	C
44980/019	3.700 g	340	440	45
44980/020	3.700 g	340	440	45

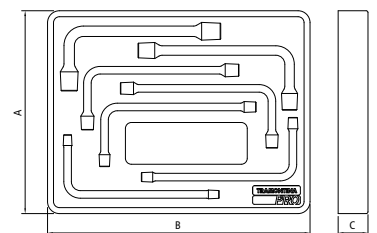

REF.	PÇS PZS PCS	CONTEÚDO CONTENIDO SET INCLUDES
44980/019		
44720	7	Chaves biela Llaves de pipa abierta Hollow offset pipe wrenches: 8, 10, 11, 13, 14, 17, 19 mm
44980/020		
44721	7	Chaves biela Llaves de pipa abierta Hollow offset pipe wrenches: 3/8", 7/16", 1/2", 9/16", 5/8", 11/16", 3/4"



REF.	PESO WEIGHT	Medidas Dimensiones Dimensions (mm)		
		A	B	C
44980/003	4.960 g	340	440	45

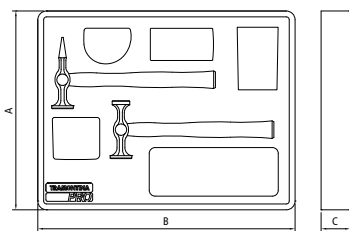

REF.	PÇS PZS PCS	CONTEÚDO CONTENIDO SET INCLUDES
40471/000	1	Martelo chapeador - faces planas Martillo para chapista - bases planas Finishing hammer - smooth faces: 310 g
40472/000	1	Martelo chapeador - pena cruzada Martillo para chapista - pena cruzada Finishing hammer - cross pein: 300 g
40482/000	1	Tasso rim Aguantador riñon Kidney dolly: 880 g
40483/000	1	Tasso recurvado Aguantador recurvado Anvil dolly: 920 g
40485/000	1	Tasso cunha Aguantador cunha Wedge dolly: 930 g
40486/000	1	Tasso salto Aguantador taco Heel dolly: 830 g

REF.	PESO WEIGHT	Medidas Dimensiones Dimensions (mm)		
		A	B	C
44980/012	380 g	340	220	45
44980/014	130 g	340	70	45
44980/026	90 g	220	55	45

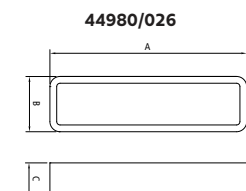
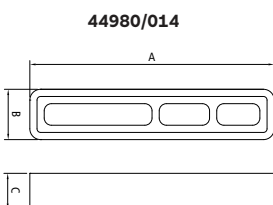
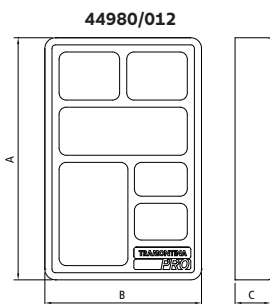

Módulo com ferramentas para chapeador

Módulo con herramientas para chapista

Finishing tool module



6 PEÇAS
PIEZAS
PIECES

TAMANHO
TAMAÑO
SIZE **B**

Utilização em cada carro |
Utilización en carros |
Use in tool cabinet:



Módulos para objetos diversos

Módulos para objetos diversos | Storage for several objects

TAMANHO
TAMAÑO
SIZE **A**

Utilização em cada carro |
Utilización en carros |
Use in tool cabinet:



44980/012

TAMANHO
TAMAÑO
SIZE **D**

Utilização em cada carro |
Utilización en carros |
Use in tool cabinet:



44980/014

TAMANHO
TAMAÑO
SIZE **E**

Utilização em cada carro |
Utilización en carros |
Use in tool cabinet:



44980/026



Composição para hidráulica / funilaria

Composición para hidráulica / hojalatería

Hydraulics / finishing tool set

REF. PESO | WEIGHT

44970/046 10.700 g

46

PEÇAS
PIEZAS
PIECES

REF.	PÇS PZS PCS	CONTEÚDO CONTENIDO SET INCLUDES
44610	14	Chaves fixas Llaves fijas Open end wrenches: 6x7, 8x9, 10x11, 12x13, 14x15, 16x17, 17x19, 18x19, 19x22, 20x22, 21x23, 24x26, 25x28, 27x32 mm
44021/014	1	Chave para tubos - modelo americano Llave para tubos - modelo americano Pipe wrench - american type: 14"
44022/010	1	Chave ajustável Llave ajustable Adjustable wrench: 10"
44001/008	1	Alicate universal isolado 1.000 V Pinza universal aislada 1.000 V 1.000 V insulated combination pliers: 8"
44003/006	1	Alicate corte diagonal isolado 1.000 V Pinza corte diagonal aislada 1.000 V 1.000 V insulated diagonal cutting pliers: 6"
44005/006	1	Alicate meia cana isolado 1.000 V Pinza media caña aislada 1.000 V 1.000 V insulated snipe nose pliers: 6"
44038/010	1	Alicate bomba d'água isolado 1.000 V Pinza pico loro aislada 1.000 V 1.000 V aislated water pump pliers: 10"
44012/010	1	Alicate de pressão mordente triangular Pinza de presión mordiente triangular Triangular jaw lock pliers: 10"
44127	4	Chaves de fenda ponta chata Destornillador punta chata Slotted tip screwdriver: 3x75, 5x100, 6x125, 8x150 mm
44127/002	1	Chave de fenda toco ponta chata Destornillador corto punta chata Stubby type slotted tip screwdriver: 6x38 mm
44128	3	Chaves de fenda ponta cruzada Destornillador punta cruzada Cross recessed tip screwdrivers: (Nr. 1) 5x100, (Nr. 2) 6x150, (Nr.3) 8x150 mm
44128/002	1	Chave de fenda toco ponta cruzada Destornillador corto punta cruzada Stubby type cross recessed tipo screwdriver: (Nr.1) 6x38 mm
44400	9	Chaves hexagonais Llaves hexagonales Hex keys: 1.5, 2, 2.5, 3, 4, 5, 6, 8, 10 mm
40440/005	1	Martelo de pena Martillo de pena Machinist's hammer: 300 g
40670/031	1	Martelo de borda em ABS Martillo de borde plástico de ABS Soft faced hammer ABS tips: 30 mm
44023/010	1	Tesoura para cortar chapa modelo americano Tijera modelo americano Snip american style: 10"
44032/012	1	Arco de serra Arco de sierra Hacksaw: 12"
44033/001	1	Faca industrial Cuchillo industrial Industrial knife
44036/030	1	Mini corta tubos Mini corta tubos Mini pipe cutter: 3-28.5 mm
44036/050	1	Corta tubos Corta tubos Pipe cutter: 12.5-50 mm



REF.	PESO WEIGHT
44970/047	6.970 g

Composição básica
Composición básica
Basic tool set

47

PEÇAS
PIEZAS
PIECES



REF.	PÇS PZS PCS	CONTEÚDO CONTENIDO SET INCLUDES
44660	11	Chaves combinadas Llaves combinadas Combination wrenches: 6, 7, 8, 9, 10, 11, 12, 13, 14, 17, 22 mm
44833	8	Soquetes estriados 1/2" Dados estriados 1/2" 1/2" 12 points sockets: 10, 11, 12, 13, 14, 17, 19, 22 mm
44835/010	1	Cabo T 1/2" mango T 1/2" 1/2" sliding T handle: 10"
44836	2	Extensões 1/2" Extensiones 1/2" 1/2" Extensions: 5", 10"
44838/001	1	Junta universal 1/2" Junta universal 1/2" 1/2" universal joint
44841/010	1	Catraca redonda 1/2" Matraca 1/2" 1/2" ratchet: 10"
44001/008	1	Alicate universal isolado 1.000 V Pinza universal aislada 1.000 V 1.000 V insulated combination pliers: 8"
44003/006	1	Alicate corte diagonal isolado 1.000 V Pinza corte diagonal aislada 1.000 V 1.000 V insulated diagonal cutting pliers: 6"
44038/010	1	Alicate bomba d'água isolado 1.000 V Pinza pico loro aislada 1.000 V 1.000 V aislated water pump pliers: 10"
44127	4	Chaves de fenda ponta chata Destornillador punta chata Slotted tip screwdrivers: 3x75, 5x100, 6x125, 8x150 mm
44128	3	Chaves de fenda ponta cruzada Destornillador punta cruzada Cross recessed tip screwdrivers: (Nr. 1) 5x100, (Nr. 2) 6x150, (Nr. 3) 8x150 mm
44400	9	Chaves hexagonais Llaves hexagonales Hex keys: 1,5, 2, 2,5, 3, 4, 5, 6, 8, 10 mm
40440/006	1	Martelo de pena Martillo de pena Machinist's hammer: 400 g
40670/031	1	Martelo de borda em ABS Martillo de borde plástico de ABS Soft faced hammer ABS tips: 30 mm
44032/012	1	Arco de serra Arco de sierra Hacksaw: 12"
44033/001	1	Faca industrial Cuchillo industrial Industrial knife

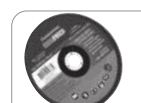

Composição para eletrônica

Composición para electrónica

Electronic tool set

REF. PESO | WEIGHT

44970/053 6.140 g

44

PEÇAS
PIEZAS
PIECES

REF.	PÇS PZS PCS	CONTEÚDO CONTENIDO SET INCLUDES
44660	8	Chaves combinadas Llaves combinadas Combination wrenches: 8, 10, 11, 13, 14, 17, 19, 22 mm
44001/008	1	Alicate universal isolado 1.000 V Pinza universal aislada 1.000 V 1.000 V insulated combination pliers: 8"
44003/006	1	Alicate corte diagonal isolado 1.000 V Pinza corte diagonal aislada 1.000 V 1.000 V insulated diagonal cutting pliers: 6"
44005/006	1	Alicate meia cana isolado 1.000 V Pinza media caña aislada 1.000 V 1.000 V insulated snipe nose pliers: 6"
44038/010	1	Alicate bomba d'água isolado 1.000 V Pinza pico loro aislada 1.000 V 1.000 V insulated water pump pliers: 10"
44008/007	1	Alicate para anéis interno reto Pinza para anillo interno recto Right internal ring pliers: 7"
44010/007	1	Alicate para anéis externo reto Pinza para anillo externo recto Right external ring pliers: 7"
44049/009	1	Alicate descascador Pinza pelacable Wire stripper: 9"
44055/001	1	Alicate crimpador Pinza crimpadora Crimping pliers: 9"
44070/001	1	Alicate diagonal Pinza diagonal Diagonal cutting pliers: 4"
44071/001	1	Alicate meia cana Pinza meia caña Snipe nose pliers: 5"
44074/001	1	Alicate bico longo Pinza punta larga Long nose pliers: 6"
44115	3	Chaves de fenda para eletrônica ponta chata Destornillador para eletrônica ponta chata Electronic slotted tip screwdrivers: 3x150, 5x150, 6x150 mm
44111/001	1	Chave de fenda toco ponta chata Destornillador corto punta chata Stubby type slotted tip screwdriver: 5x38 mm
44116	3	Chaves de fenda ponta cruzada Destornillador ponta cruzada Cross recessed tip screwdrivers: (Nr. 0) 3x150, (Nr. 1) 5x150, (Nr.2) 6x150 mm
44113/001	1	Chave de fenda toco ponta cruzada Destornillador corto punta cruzada Stubby type cross recessed tipo screwdriver: (Nr.1) 5x38 mm
44250	6	Chaves canhão Destornilladores de tuerca Nut drivers: 5, 6, 7, 8, 9, 10 mm
44400	9	Chaves hexagonais Llaves hexagonales Hex keys: 1.5, 2, 2.5, 3, 4, 5, 6, 8, 10 mm
40440/005	1	Martelo de pena Martillo de pena Machinist's hammer: 300 g
40670/031	1	Martelo de borda em ABS Martillo de borde plástico de ABS Soft faced hammer ABS tips: 30 mm



REF.	PESO WEIGHT
44970/063	16.290 g

Composição para chapeador / soldador
Composición para chapista / soldador
Finishing / welding tool set

63 PEÇAS
PIEZAS
PIECES



REF.	PÇS PZS PCS	CONTEÚDO CONTENIDO SET INCLUDES
44660	17	Chaves combinadas Llaves combinadas Combination wrenches: 6, 7, 8, 9, 10, 11, 12, 13, 14, 15, 16, 17, 18, 19, 20, 21, 22 mm
44001/008	1	Alicate universal isolado 1.000 V Pinza universal aislada 1.000 V 1.000 V insulated combination pliers: 8"
44003/006	1	Alicate corte diagonal isolado 1.000 V Pinza corte diagonal aislada 1.000 V 1.000 V insulated diagonal cutting pliers: 6"
44038/010	1	Alicate bomba d'água isolado 1.000 V Pinza pico loro aislada 1.000 V 1.000 V insulated water pump pliers: 10"
44012/010	1	Alicate de pressão mordente triangular Pinza de presión mordiente triangular Triangular jaw lock pliers: 10"
44016/010	1	Alicate de pressão tipo U Pinza de presión tipo U Lock pliers - U type: 10"
44018/011	1	Alicate de pressão para soldar chapa Pinza de presión para soldar chapa Lock pliers for welding jobs: 11"
44019/010	1	Alicate de pressão tipo plataforma Pinza de presión tipo plataforma Lock pliers - platform type: 10"
44120	4	Chaves de fenda ponta chata Destornillador punta chata Slotted tip screwdrivers: 3x75, 5x100, 6x125, 8x150 mm
44121/002	1	Chave de fenda toco ponta chata Destornillador corto punta chata Stubby type slotted tip screwdriver: 6x38 mm
44122	4	Chaves de fenda ponta cruzada Destornillador punta cruzada Cross recessed tip screwdrivers: (Nr. 0) 3x75, (Nr. 1) 5x100, (Nr. 2) 6x150, (Nr. 3) 8x150 mm
44123/002	1	Chave de fenda toco ponta cruzada Destornillador corto punta cruzada Stubby type cross recessed tip screwdriver: (Nr.1) 6x38 mm
44400	9	Chaves hexagonais Llaves hexagonales Hex keys: 1.5, 2, 2.5, 3, 4, 5, 6, 8, 10 mm
40440/006	1	Martelo de pena Martillo de pena Machinist's hammer: 400 g
40670/031	1	Martelo de borda em ABS Martillo de borde plástico de ABS Soft faced hammer ABS tips: 30 mm
40471/000	1	Martelo chapeador - faces planas Martillo para chapista - bases planas Finishing hammer - smooth faces: 310 g
40472/000	1	Martelo chapeador - pena cruzada Martillo para chapista - pena cruzada Finishing hammer - cross pein: 300 g
40473/000	1	Martelo chapeador - pena curta Martillo para chapista - pena corta Finishing hammer - short pein: 300 g
40474/000	1	Martelo chapeador - pena reta Martillo para chapista - pena reta Finishing hammer - straight pein: 350 g
40481/000	1	Tasso triho Aguantador riel General purpose dolly: 1.150 g
40482/000	1	Tasso rim Aguantador riñon Kidney dolly: 900 g
40483/000	1	Tasso recurvado Aguantador recurvado Anvil dolly: 900 g
40484/000	1	Tasso maçaneta Aguantador remache Diabolo dolly: 800 g
40485/000	1	Tasso cunha Aguantador cunha Wedge dolly: 1.060 g
40486/000	1	Tasso salto Aguantador taco Heel dolly: 900 g
44470/006	1	Saca pino cônico Botador Solid punch: 6 mm
44471	2	Saca pinos paralelos Botadores Solid punches: 4, 5 mm
44472	2	Punções de centro Centros punto Center punches: 4, 5 mm
44473	2	Talhadeiras Cinceles Cold chisels: 16, 19 mm
44023/001	1	Tesoura de aviação - corte reto Tijera de aviación - corte recto Aviation snips - straight cut

Composição para manutenção automotiva / industrial
Composición para mantenimiento automotriz / industrial
Automotive / industrial maintenance tool set

REF.	PESO WEIGHT
44970/074	10.950 g

74
 PEÇAS
 PIEZAS
 PIECES



REF.	PÇS PZS PCS	CONTEÚDO CONTENIDO SET INCLUDES
44660	17	Chaves combinadas Llaves combinadas Combination wrenches: 6, 7, 8, 9, 10, 11, 12, 13, 14, 15, 16, 17, 18, 19, 20, 21, 22 mm
44833/522	1	Jogo de soquetes estriados 1/2" 22 peças Juego de dados estriados 1/2" 22 piezas 22 pieces 1/2" 12 points socket set
44001/008	1	Alicate universal isolado 1.000 V Pinza universal aislada 1.000 V 1.000 V insulated combination pliers: 8"
44003/006	1	Alicate corte diagonal isolado 1.000 V Pinza corte diagonal aislada 1.000 V 1.000 V insulated diagonal cutting pliers: 6"
44005/006	1	Alicate meia cana isolado 1.000 V Pinza media caña aislada 1.000 V 1.000 V insulated snipe nose pliers: 6"
44038/010	1	Alicate bomba d'água isolado 1.000 V Pinza pico loro aislada 1.000 V 1.000 V insulated water pump pliers: 10"
44008/007	1	Alicate para anéis interno reto Pinza para anillo interno recto Right internal ring pliers: 7"
44010/007	1	Alicate para anéis externo reto Pinza para anillo externo recto Right external ring pliers: 7"
44012/010	1	Alicate de pressão mordente triangular Pinza de presión mordiente triangular Triangular jaw lock pliers: 10"
44120	4	Chaves de fenda ponta chata Destornillador punta chata Slotted tip screwdrivers: 3x75, 5x100, 6x125, 8x150 mm
44121/002	1	Chave de fenda toco ponta chata Destornillador corto punta chata Stubby type slotted tip screwdriver: 6x38 mm
44122	3	Chaves de fenda ponta cruzada Destornillador punta cruzada Cross recessed tip screwdrivers: (Nr. 1) 5x100, (Nr. 2) 6x150, (Nr. 3) 8x150 mm
44123/002	1	Chave de fenda toco ponta cruzada Destornillador corto punta cruzada Stubby type cross recessed tip screwdriver: (Nr. 1) 6x38 mm
44400	9	Chaves hexagonais Llaves hexagonales Hex keys: 1.5, 2, 2.5, 3, 4, 5, 6, 8, 10 mm
40440/006	1	Martelo de pena Martillo de pena Machinist's hammer: 400 g
40670/031	1	Martelo de borda em ABS Martillo de borde plástico de ABS Soft faced hammer ABS tips: 30 mm
44470/006	1	Saca pino cônico Botador Solid punch: 6 mm
44471	2	Saca pinos paralelos Botadores Solid punches: 4, 5 mm
44472	2	Punções de centro Centros punto Center punches: 4, 5 mm
44473	2	Talhadeiras Cinceles Cold chisels: 16, 19 mm
44033/001	1	Faca industrial Cuchillo industrial Industrial knife



REF.	PESO WEIGHT
44970/107	19.520 g

Composição para manutenção automotiva / industrial
Composición para mantenimiento automotriz / industrial
Automotive / industrial maintenance tool set

107
PEÇAS
PIEZAS
PIECES

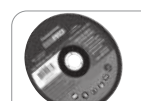

REF.	PÇS PZS PCS	CONTEÚDO CONTENIDO SET INCLUDES
44660	17	Chaves combinadas Llaves combinadas Combination wrenches: 6, 7, 8, 9, 10, 11, 12, 13, 14, 15, 16, 17, 18, 19, 20, 21, 22 mm
44610	14	Chaves fixas Llaves fijas Open end wrenches: 6x7, 8x9, 10x11, 12x13, 14x15, 16x17, 18x19, 20x22, 21x23, 24x26, 25x28, 27x32, 30x32, 30x34 mm
44675	3	Chaves estrela meia lua Llaves estriadas media luna Obstruction ring wrenches: 11x13, 14x16, 15x17 mm
44833/522	1	Jogo de soquetes estriados 1/2" 22 peças Juego de dados estriados 1/2" 22 piezas 22 pieces 1/2" 12 points socket set
44001/008	1	Alicate universal isolado 1.000 V Pinza universal aislada 1.000 V 1.000 V insulated combination pliers: 8"
44003/006	1	Alicate corte diagonal isolado 1.000 V Pinza corte diagonal aislada 1.000 V 1.000 V insulated diagonal cutting pliers: 6"
44005/006	1	Alicate meia cana isolado 1.000 V Pinza media caña aislada 1.000 V 1.000 V insulated snipe nose pliers: 6"
44008/007	1	Alicate para anéis interno reto Pinza para anillo interno reto Right internal ring pliers: 7"
44009/007	1	Alicate para anéis interno curvo Pinza para anillo interno curvo Curved internal ring pliers: 7"
44010/007	1	Alicate para anéis externo reto Pinza para anillo externo reto Right external ring pliers: 7"
44011/007	1	Alicate para anéis externo curvo Pinza para anillo externo curvo Curved external ring pliers: 7"
44012/010	1	Alicate de pressão mordente triangular Pinza de presión mordiente triangular Triangular jaw lock pliers: 10"
44038/010	1	Alicate bomba d'água isolado 1.000 V Pinza pico loro aislada 1.000 V 1.000 V insulated water pump pliers: 10"
44120	4	Chaves de fenda ponta chata Destornillador punta chata Slotted tip screwdriver: 3x75, 5x100, 6x125, 8x150 mm
44121/002	1	Chave de fenda toco ponta chata Destornillador corto punta chata Stubby type slotted tip screwdriver: 6x38 mm
44122	4	Chaves de fenda ponta cruzada Destornillador punta cruzada Cross recessed tip screwdrivers: (Nr. 0) 3x75, (Nr. 1) 5x100, (Nr. 2) 6x150, (Nr. 3) 8x150 mm
44123/002	1	Chave de fenda toco ponta cruzada Destornillador corto punta cruzada Stubby type cross recessed tipo screwdriver: (Nr. 1) 6x38 mm
44400	9	Chaves hexagonais Llaves hexagonales Hex keys: 1,5, 2, 2,5, 3, 4, 5, 6, 8, 10 mm
44450	9	Chaves Trafix Llaves Trafix Trafix hex keys: T10, T15, T20, T25, T27, T30, T40, T45, T50
40400/016	1	Martelo de bola Martillo de bola Ball pein hammer: 400 g 16 oz
40440/006	1	Martelo de pena Martillo de pena Machinist's hammer: 400 g
40670/031	1	Martelo de borda em ABS Martillo de borde plástico de ABS Soft faced hammer ABS tips: 30 mm
44470/006	1	Saca pino cônico botador Solid punch: 6 mm
44471	2	Saca pinos paralelos Botadores Solid punches: 4, 5 mm
44472	2	Punções de centro Centro puntos Center punches: 4, 5 mm
44473	2	Talhadeiras Cinceles Cold chisels: 16, 19 mm
44032/012	1	Arco de serra Arco de sierra Hacksaw: 12"
44033/001	1	Faca industrial Cuchillo industrial Industrial knife
44048/001	1	Bomba manual de graxa bomba engrasadora manual lever grease gun
44710/001	1	Chave de roda cruz com espátula Llave en cruz con espátula Cross wrench with chisel: 17x19x21 mm

Composição para manutenção automotiva / industrial
Composición para mantenimiento automotriz / industrial
Automotive / industrial maintenance tool set

REF.	PESO WEIGHT
44970/141	26.160 g

141
PEÇAS
PIEZAS
PIECES



REF.	PÇS PZS PCS	CONTEÚDO CONTENIDO SET INCLUDES
44660	17	Chaves combinadas Llaves combinadas Combination wrenches: 6, 7, 8, 9, 10, 11, 12, 13, 14, 15, 16, 17, 18, 19, 20, 21, 22 mm
44610	14	Chaves fixas Llaves fijas Open end wrenches: 6x7, 8x9, 10x11, 12x13, 14x15, 16x17, 18x19, 20x22, 21x23, 24x26, 25x28, 27x32, 30x32, 30x34 mm
44630	12	Chaves estrela Llaves estriadas Ring spanners: 6x7, 8x9, 10x11, 12x13, 14x15, 16x17, 18x19, 20x22, 21x23, 24x26, 25x28, 27x32 mm
44675	3	Chaves estrela meia lua Llaves estriadas media luna Obstruction ring wrenches: 11x13, 14x16, 15x17 mm
44022/010	1	Chave ajustável Llave ajustable Adjustable wrench: 10"
44833/522	1	Jogo de soquetes estriados 1/2" 22 peças Juego de dados estriados 1/2" 22 piezas 22 piezas 1/2" 12 points socket set
44844	5	Soquetes 1/2" ponta Trafix Dados 1/2" ponta Trafix 1/2" sockets Trafix tips: T40, T45, T50, T55, T60
44847	8	Soquetes 1/2" ponta Trafix fêmea Dados 1/2" ponta Trafix hembra 1/2" sockets Trafix tip female: E10, E11, E12, E14, E16, E18, E20, E24
44880	5	Soquetes de impacto 1/2" Dados de impacto 1/2" 1/2" impact sockets: 17, 19, 21, 22, 24 mm.
44001/008	1	Alicate universal isolado 1.000 V Pinza universal aislada 1.000 V 1.000 V insulated combination pliers: 8"
44003/006	1	Alicate corte diagonal isolado 1.000 V Pinza corte diagonal aislada 1.000 V 1.000 V insulated diagonal cutting pliers: 6"
44005/006	1	Alicate meia cana isolado 1.000 V Pinza media caña aislada 1.000 V 1.000 V insulated snipe nose pliers: 6"
44008/007	1	Alicate para anéis interno reto Pinza para anillo interno recto Right internal ring pliers: 7"
44009/007	1	Alicate para anéis interno curvo Pinza para anillo interno curvo Curved internal ring pliers: 7"
44010/007	1	Alicate para anéis externo reto Pinza para anillo externo recto Right external ring pliers: 7"
44011/007	1	Alicate para anéis externo curvo Pinza para anillo externo curvo Curved external ring pliers: 7"
44012/010	1	Alicate de pressão mordente triangular Pinza de presión mordiente triangular Triangular jaw lock pliers: 10"
44038/010	1	Alicate bomba d'água isolado 1.000 V Pinza pico loro aislada 1.000 V 1.000 V aislated water pump pliers: 10"
44049/009	1	Alicate descascador Pinza pelacable Wire stripper: 9"
44120	4	Chaves de fenda ponta chata Destornillador punta chata Slotted tip screwdrivers: 3x75, 5x100, 6x125, 8x150 mm
44121/002	1	Chave de fenda toco ponta chata Destornillador corto punta chata Stubby type slotted tip screwdriver: 6x38 mm
44122	4	Chaves de fenda ponta cruzada Destornillador punta cruzada Cross recessed tip screwdrivers: (Nr. 0) 3x75, (Nr. 1) 5x100, (Nr. 2) 6x150, (Nr. 3) 8x150 mm
44123/002	1	Chave de fenda toco ponta cruzada Destornillador corto punta cruzada Stubby type cross recessed tipo screwdriver: (Nr.1) 6x38 mm
44400	9	Chaves hexagonais Llaves hexagonales Hex keys: 1,5, 2, 2,5, 3, 4, 5, 6, 8, 10 mm
44450	9	Chaves Trafix Llaves Trafix Trafix hex keys: T10, T15, T20, T25, T27, T30, T40, T45, T50
40400/016	1	Martelo de bola Martillo de bola Ball pein hammer: 400 g 16 oz
40440/006	1	Martelo de pena Martillo de pena Machinist's hammer: 400 g
40670/031	1	Martelo de borda em ABS Martillo de borde plástico de ABS Soft faced hammer ABS tips: 30 mm
44470/006	1	Saca pino cônico botador Solid punch: 6 mm
44471	2	Saca pinos paralelos Botadores Solid punches: 4, 5 mm
44472	2	Punções de centro Centro puntos Center punches: 4, 5 mm
44473	2	Talhadeiras Cinceles Cold chisels: 16, 19 mm
44032/012	1	Arco de serra Arco de sierra Hacksaw: 12"
44033/001	1	Faca industrial Cuchillo industrial Industrial knife
44023/010	1	Tesoura para cortar chapa modelo americano Tijera modelo americano Snip american style: 10"
44048/001	1	Bomba manual de graxa bomba engrasadora manual lever grease gun
44040/011	1	Chave corrente leve Llave cadena liviana Light chain wrench: 11"
44710/001	1	Chave de roda cruz com espátula Llave en cruz con espátula Cross wrench with chisel: 17x19x21 mm





INFORMAÇÕES ADICIONAIS

Informaciones adicionales | Additional information

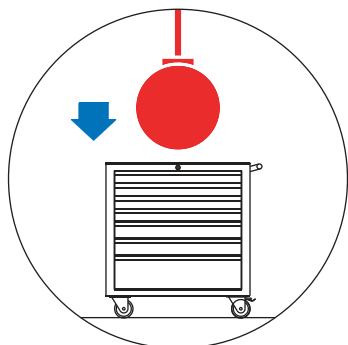

Os carros e bancadas são testados em ensaios de carga, para garantir sua resistência durante a utilização na oficina ou indústria.

Los carros y bancadas son testados en ensayos de carga, para garantizar su resistencia durante la utilización en talleres mecánicos o industria.

The cabinets and workbenches are load tested, to ensure their strength when used by mechanics or in industry.

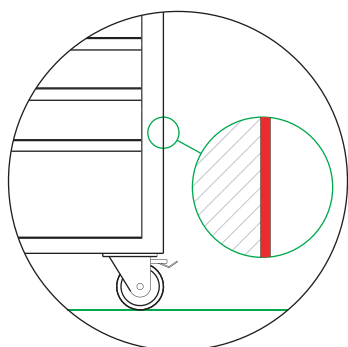

A pintura eletrostática forma uma película protetiva que garante um acabamento excelente e resistência à corrosão.

La pintura electrostática forma una capa protectora que garantiza un excelente acabado y resistencia a la corrosión.

The electrostatic paint provides a protective layer that ensures an excellent finish and is resistant to rust.

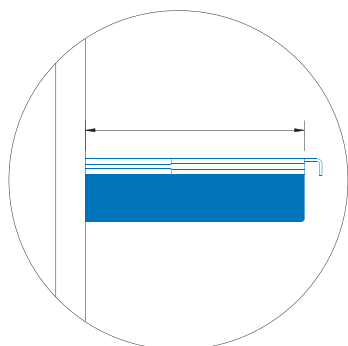

As gavetas que estão na linha de carros e bancadas possuem corredeiras tipo telescópica. As telescópicas são eficazes na movimentação da gaveta e permitem maior abertura.

Los cajones que están en la línea de carros y bancadas poseen rieles telescópicos que son eficaces en el movimiento del cajón y permiten mayor apertura.

The drawers that are in the cabinets and workbenches have ball bearing slides, which allow efficient drawer movement and maximum opening.

Os carros, caixas e composições são produzidos e testados conforme normas específicas.

Los carros, cajas y composiciones son producidos y testados bajo especificaciones internas.

Cabinets, boxes and tool sets are produced and tested according to plant specifications.

