



7

# CHAVES TIPO L

LLAVES HEXAGONALES

HEX KEYS

## Chaves hexagonais Llaves hexagonales | Hex keys

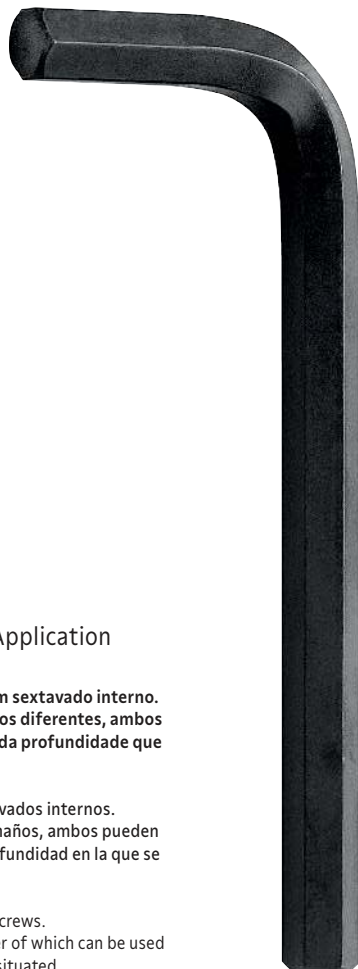

Acabamento fosfatizado.  
DIN ISO 2936 (milímetros).  
ASME B18.3 (polegadas).

Acabado fosfatado.  
DIN ISO 2936 (milímetros).  
ASME B18.3 (pulgadas).

Phosphated finishing.  
DIN ISO 2936 (millimeters).  
ASME B18.3 (inches).

### Aplicações | Aplicación | Application

- Apertar ou afrouxar parafusos com sextavado interno.
- Possui dois braços de comprimentos diferentes, ambos podem ser utilizados, dependendo da profundidade que será realizado o trabalho.

- Ajustar o aflojar tornillos com sextavados internos.
- Posee dos brazos de diferentes tamaños, ambos pueden ser utilizados dependiendo de la profundidad en la que se desea realizar el trabajo.

- Tightening or loosening hexagonal screws.
- Two arms of different lengths; either of which can be used depending on how deep the screw is situated.

#### MATERIAL | MATERIAL | MATERIAL

##### mm

De 44400/000 até 44400/008 haste em aço ferramenta S2 e temperada.  
De 44400/000 até 44400/008 asta en acero especial S2 y templada.  
From 44400/000 up to 44400/008 hardened S2 steel blade.

De 44400/009 até 44400/024 haste em aço cromo vanádio temperada.  
De 44400/009 até 44400/024 asta en acero cromo vanadio templada.  
From 44400/009 up to 44400/024 hardened chrome vanadium steel blade.

##### polegadas / pulgadas / inches

De 44420/001 até 44420/010 haste em aço ferramenta S2 e temperada.  
De 44420/001 até 44420/010 asta en acero especial S2 y templada.  
From 44420/001 up to 44420/010 hardened S2 steel blade.

De 44420/011 até 44420/018 haste em aço cromo vanádio temperada.  
De 44420/011 até 44420/018 asta en acero cromo vanadio templada.  
From 44420/011 up to 44420/018 hardened chrome vanadium steel blade.

REF.	TAMANHO TAMAÑO   SIZE - mm	PESO   WEIGHT	Medidas   Dimensiones   Dimensions (mm)		
			A	B	C
44400/000	1.5	10 g	14	45	1,5
44400/001	2.0	10 g	16	50	2,0
44400/002	2.5	10 g	18	56	2,5
44400/003	3.0	10 g	20	63	3,0
44400/004	4.0	20 g	25	70	4,0
44400/005	5.0	20 g	28	80	5,0
44400/006	6.0	30 g	32	90	6,0
44400/007	7.0	50 g	34	95	7,0
44400/008	8.0	70 g	36	100	8,0
44400/009	9.0	90 g	38	106	9,0
44400/010	10.0	110 g	40	112	10,0
44400/011	11.0	140 g	43	120	11,0
44400/012	12.0	170 g	45	125	12,0
44400/014	14.0	270 g	56	140	14,0
44400/016	16.0	380 g	60	150	16,0
44400/017	17.0	460 g	63	160	17,0
44400/019	19.0	630 g	70	180	19,0
44400/022	22.0	960 g	80	200	22,0
44400/024	24.0	1.270 g	90	224	24,0

REF.	POLEGADAS PULGADAS INCHES	PESO   WEIGHT	Medidas   Dimensiones   Dimensions (mm)		
			A	B	C
44420/001	1/16"	10 g	14	45	1,59
44420/002	5/64"	10 g	16	50	1,98
44420/003	3/32"	10 g	18	56	2,38
44420/004	1/8"	10 g	20	63	3,18
44420/005	9/64"	20 g	22	66	3,57
44420/006	5/32"	20 g	25	70	3,97
44420/007	3/16"	20 g	28	80	4,76
44420/008	7/32"	30 g	30	85	5,56
44420/009	1/4"	40 g	32	90	6,35
44420/010	5/16"	60 g	36	100	7,94
44420/011	3/8"	10 g	40	112	9,53
44420/012	7/16"	140 g	42	120	11,11
44420/013	1/2"	210 g	45	125	12,70
44420/014	9/16"	280 g	56	140	14,29
44420/015	5/8"	370 g	63	160	15,88
44420/016	3/4"	640 g	70	180	19,05
44420/017	7/8"	960 g	80	200	22,23
44420/018	1"	1.480 g	90	235	25,40

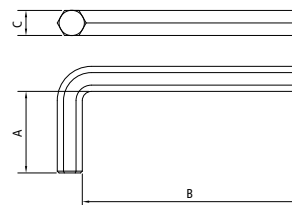

REF.	PÇS   PZS   PCS	CONTEÚDO   CONTENIDO   SET INCLUDES
<b>44400/209 - 9 pçs   pzs   pcs</b>		
44400	9	<b>Chaves hexagonais</b>   Llaves hexagonales   Hex keys: 1.5, 2, 2.5, 3, 4, 5, 6, 8, 10 mm <b>Embalagem injetada em borracha termoplástica (PPE)</b> Embalaje de goma termoplástica inyectada (PPE) Packing injected thermoplastic rubber (PPE)
<b>44420/209 - 9 pçs   pzs   pcs</b>		
44420	9	<b>Chaves hexagonais</b>   Llaves hexagonales   Hex keys: 1/16"; 5/64"; 3/32"; 1/8"; 5/32"; 3/16"; 1/4"; 5/16"; 3/8"
		<b>Embalagem injetada em borracha termoplástica (PPE)</b> Embalaje de goma termoplástica inyectada (PPE) Packing injected thermoplastic rubber (PPE)

REF.	PÇS   PZS   PCS	CONTEÚDO   CONTENIDO   SET INCLUDES
<b>44400/505</b>		
44400	5	<b>Chaves hexagonais</b>   Llaves hexagonales   Hex keys: 2.5, 3, 4, 6, 8 mm
<b>44400/207</b>		
44400	7	<b>Chaves hexagonais</b>   Llaves hexagonales   Hex keys: 2, 2.5, 3, 4, 5, 6, 8 mm
<b>44400/297</b>		
44400	7	<b>Chaves hexagonais</b>   Llaves hexagonales   Hex keys: 1.5, 2, 2.5, 3, 4, 5, 6 mm
<b>44400/208</b>		
44400	8	<b>Chaves hexagonais</b>   Llaves hexagonales   Hex keys: 2, 2.5, 3, 4, 5, 6, 8, 10 mm
<b>44400/288</b>		
44400	8	<b>Chaves hexagonais</b>   Llaves hexagonales   Hex keys: 2, 3, 4, 5, 6, 7, 8, 10 mm
<b>44400/298</b>		
44400	8	<b>Chaves hexagonais</b>   Llaves hexagonales   Hex keys: 3, 4, 5, 6, 8, 10, 12, 14 mm
<b>44400/210</b>		
44400	10	<b>Chaves hexagonais</b>   Llaves hexagonales   Hex keys: 3, 4, 5, 6, 7, 8, 9, 10, 12, 14 mm
<b>44400/290</b>		
44400	10	<b>Chaves hexagonais</b>   Llaves hexagonales   Hex keys: 2, 2.5, 3, 4, 5, 6, 7, 8, 9, 10 mm
<b>44400/211</b>		
44400	11	<b>Chaves hexagonais</b>   Llaves hexagonales   Hex keys: 1.5, 2, 2.5, 3, 4, 5, 6, 7, 8, 9, 10 mm
<b>44400/299</b>		
44400	19	<b>Chaves hexagonais</b>   Llaves hexagonales   Hex keys: 1.5, 2, 2.5, 3, 4, 5, 6, 7, 8, 9, 10, 11, 12, 14, 16, 17, 19, 22, 24 mm
<b>44420/207</b>		
44420	7	<b>Chaves hexagonais</b>   Llaves hexagonales   Hex keys: 5/64", 3/32", 1/8", 5/32", 3/16", 7/32", 1/4"
<b>44420/208</b>		
44420	8	<b>Chaves hexagonais</b>   Llaves hexagonales   Hex keys: 1/16", 5/64", 3/32", 1/8", 5/32", 3/16", 7/32", 1/4"
<b>44420/298</b>		
44420	8	<b>Chaves hexagonais</b>   Llaves hexagonales   Hex keys: 3/32", 1/8", 5/32", 3/16", 7/32", 1/4", 5/16", 3/8"
<b>44420/210</b>		
44420	10	<b>Chaves hexagonais</b>   Llaves hexagonales   Hex keys: 1/8", 5/32", 3/16", 7/32", 1/4", 5/16", 3/8", 7/16", 1/2", 9/16"
<b>44420/212</b>		
44420	12	<b>Chaves hexagonais</b>   Llaves hexagonales   Hex keys: 1/16", 5/64", 3/32", 1/8", 5/32", 3/16", 7/32", 1/4", 5/16", 3/8", 7/16", 1/2"
<b>44420/218</b>		
44420	18	<b>Chaves hexagonais</b>   Llaves hexagonales   Hex keys: 1/16", 5/64", 3/32", 1/8", 9/64", 5/32", 3/16", 7/32", 1/4", 5/16", 3/8", 7/16", 1/2", 9/16", 5/8", 3/4", 7/8", 1"

## Jogo de chaves hexagonais

Juego de llaves hexagonales | Hex keys set



**9** PEÇAS  
PIEZAS  
PIECES



## Jogo de chaves hexagonais

Juego de llaves hexagonales | Hex keys set



**Embalagem injetada em borracha termoplástica (PPE).**  
Embalaje de goma termoplástica inyectada (PPE).  
Packing injected thermoplastic rubber (PPE).

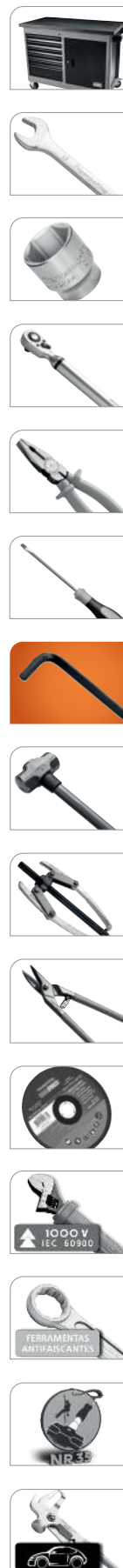

## Jogo de chaves hexagonais com armação

Juego de llaves hexagonales | Hex keys set  
Milímetros | Milímetros | Millimeters



**7** PEÇAS  
PIEZAS  
PIECES



Chaves em aço ferramenta S2 e temperada.  
Acabamento fosfatizado.  
Armação com estrutura em aço e coberta de plástico reforçado.

Llaves en acero especial S2 y templada.  
Acabado fosfatado.  
Estructura en acero cubierta de plástico reforzado.

Hardened S2 steel blade.  
Phosphated finishing.  
Steel core plastic holder.

REF.	PESO   WEIGHT	Medidas   Dimensiones   Dimensions (mm)		
		A	B	C
44401/207	260 g	37,5	130	30

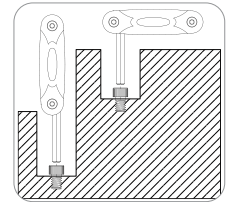
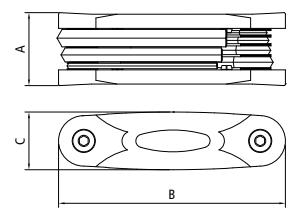

REF.	PÇS   PZS   PCS	CONTEÚDO   CONTENIDO   SET INCLUDES
	7	Chaves hexagonais   Llaves hexagonales   Hex keys: 2, 2.5, 3, 4, 5, 6, 8 mm

## Estojo com chaves hexagonais

Estuche con llaves hexagonales | Hex keys case



**22** PEÇAS  
PIEZAS  
PIECES



REF.	PESO   WEIGHT	Medidas   Dimensiones   Dimensions (mm)		
		A	B	C
44420/222	940 g	155	170	57

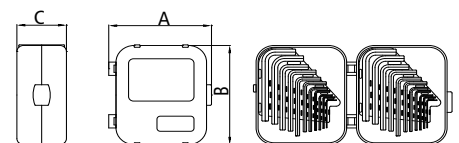

REF.	PÇS   PZS   PCS	CONTEÚDO   CONTENIDO   SET INCLUDES
44400	11	Chaves hexagonais   Llaves hexagonales   Hex keys: 1.5, 2, 2.5, 3, 4, 5, 6, 7, 8, 9, 10 mm
44420	11	Chaves hexagonais   Llaves hexagonales   Hex keys: 1/16", 5/64", 3/32", 1/8", 9/64", 5/32", 3/16", 7/32", 1/4", 5/16", 3/8"
	1	Maleta plástica   Maletín plástico   Plastic case



REF.	TAMANHO TAMANO   SIZE - mm	PESO   WEIGHT	Medidas   Dimensiones   Dimensions (mm)		
			A	B	C
44421/015	1.5	10 g	14	62	1,5
44421/002	2.0	10 g	16	75	2,0
44421/025	2.5	10 g	18	85	2,5
44421/003	3.0	10 g	20	90	3,0
44421/004	4.0	20 g	25	100	4,0
44421/005	5.0	30 g	28	115	5,0
44421/006	6.0	40 g	32	135	6,0
44421/007	7.0	60 g	34	140	7,0
44421/008	8.0	90 g	36	150	8,0
44421/009	9.0	110 g	38	160	9,0
44421/010	10.0	150 g	40	170	10,0
44421/011	11.0	190 g	42	180	11,0
44421/012	12.0	240 g	45	190	12,0
44421/014	14.0	370 g	56	215	14,0
44421/017	17.0	610 g	63	245	17,0
44421/019	19.0	790 g	70	270	19,0

REF.	POLEGADAS PULGADAS INCHES	PESO   WEIGHT	Medidas   Dimensiones   Dimensions (mm)		
			A	B	C
44422/001	1/16"	10 g	17	77,0	1,59
44422/002	5/64"	10 g	18	81,0	1,98
44422/003	3/32"	10 g	19	85,5	2,38
44422/004	7/64"	10 g	20	90,0	2,78
44422/005	1/8"	20 g	21	94,5	3,18
44422/006	9/64"	20 g	23	99,0	3,57
44422/007	5/32"	20 g	24	103,0	3,97
44422/008	3/16"	30 g	25	112,0	4,76
44422/009	7/32"	40 g	29	120,0	5,56
44422/010	1/4"	50 g	31	130,0	6,35
44422/012	5/16"	90 g	34	147,0	7,94
44422/013	3/8"	130 g	38	164,0	9,53
44422/014	7/16"	190 g	41	182,0	11,19
44422/015	1/2"	280 g	45	200,0	12,70
44422/016	9/16"	370 g	47	217,0	14,29
44422/017	5/8"	500 g	50	234,0	15,88

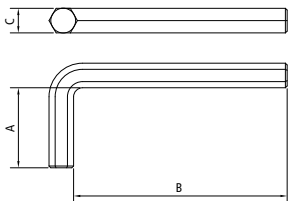

## Chaves hexagonais longas

### Llaves hexagonales largas | Long hex keys



Acabamento fosfatizado.  
DIN ISO 2936 (milímetros).  
ASME B18.3 (polegadas).

Acabado fosfatado.  
DIN ISO 2936 (milímetros).  
ASME B18.3 (pulgadas).

Phosphated finishing.  
DIN ISO 2936 (millimeters).  
ASME B18.3 (inches).

### Aplicações | Aplicación | Application

- Apertar ou afrouxar parafusos com sextavado interno.
- Possui dois braços de comprimentos diferentes, ambos podem ser utilizados, dependendo da profundidade que será realizado o trabalho.

- Ajustar o aflojar tornillos con sextavados internos.
- Posee dos brazos de diferentes tamaños, ambos pueden ser utilizados dependiendo de la profundidad en la que se desea realizar el trabajo.

- Tightening or loosening hexagonal screws.
- Two arms of different lengths; either of which can be used depending on how deep the screw is situated.



### MATERIAL | MATERIAL | MATERIAL

#### mm

De 44421/015 até 44421/008 haste em aço ferramenta S2 e temperada.  
De 44421/015 até 44421/008 asta en acero especial S2 y templada.  
From 44421/015 up to 44421/008 hardened S2 steel blade.

De 44421/009 até 44421/019 haste em aço cromo vanádio temperada.  
De 44421/009 até 44421/019 asta en acero cromo vanadio templada.  
From 44421/009 up to 44421/019 hardened chrome vanadium steel blade.

#### polegadas / pulgadas / inches

De 44422/001 até 44422/012 haste em aço ferramenta S2 e temperada.  
De 44422/001 até 44422/012 asta en acero especial S2 y templada.  
From 44422/001 up to 44422/012 hardened S2 steel blade.

De 44422/013 até 44422/017 haste em aço cromo vanádio temperada.  
De 44422/013 até 44422/017 asta en acero cromo vanadio templada.  
From 44422/013 up to 44422/017 hardened chrome vanadium steel blade.

## Jogo de chaves hexagonais longas Juego llaves hexagonales largas | Long hex keys set



Embalagem injetada em borracha termoplástica (PPE).  
Embalaje de goma termoplástica injectada (PPE).  
Packing injected thermoplastic rubber (PPE).

REF.	PÇS   PZS   PCS	CONTEÚDO   CONTENIDO   SET INCLUDES
44421/207		
44421	7	Chaves hexagonais   Llaves hexagonales   Hex keys: 2, 2.5, 3, 4, 5, 6, 8 mm
44421/208		
44421	8	Chaves hexagonais   Llaves hexagonales   Hex keys: 3, 4, 5, 6, 8, 10, 12, 14 mm
44421/298		
44421	8	Chaves hexagonais   Llaves hexagonales   Hex keys: 2, 2.5, 3, 4, 5, 6, 8, 10 mm
44421/209		
44421	9	Chaves hexagonais   Llaves hexagonales   Hex keys: 1.5, 2, 2.5, 3, 4, 5, 6, 8, 10 mm
44421/200		
44421	10	Chaves hexagonais   Llaves hexagonales   Hex keys: 2, 2.5, 3, 4, 5, 6, 7, 8, 9, 10 mm
44421/210		
44421	10	Chaves hexagonais   Llaves hexagonales   Hex keys: 3, 4, 5, 6, 7, 8, 9, 10, 12, 14 mm
44421/211		
44421	11	Chaves hexagonais   Llaves hexagonales   Hex keys: 1.5, 2, 2.5, 3, 4, 5, 6, 7, 8, 9, 10 mm
44421/214		
44421	14	Chaves hexagonais   Llaves hexagonales   Hex keys: 1.5, 2, 2.5, 3, 4, 5, 6, 7, 8, 9, 10, 11, 12, 14 mm
44422/207		
44422	7	Chaves hexagonais   Llaves hexagonales   Hex keys: 5/64", 3/32", 1/8", 5/32", 3/16", 7/32", 1/4"
44422/208		
44422	8	Chaves hexagonais   Llaves hexagonales   Hex keys: 3/32", 1/8", 5/32", 3/16", 7/32", 1/4", 5/16", 3/8"
44422/209		
44422	9	Chaves hexagonais   Llaves hexagonales   Hex keys: 1/16", 5/64", 3/32", 1/8", 5/32", 3/16", 1/4", 5/16", 3/8"
44422/210		
44422	10	Chaves hexagonais   Llaves hexagonales   Hex keys: 1/8", 5/32", 3/16", 7/32", 1/4", 5/16", 3/8", 7/16", 1/2", 9/16"
44422/214		
44422	14	Chaves hexagonais   Llaves hexagonales   Hex keys: 1/16", 5/64", 3/32", 1/8", 9/64", 5/32", 3/16", 7/32", 1/4", 5/16", 3/8", 7/16", 1/2", 9/16"

## Jogo de chaves hexagonais longas Juego llaves hexagonales largas | Long hex keys set



**28** PEÇAS  
PIEZAS  
PIECES



REF.	PÇS   PZS   PCS	CONTEÚDO   CONTENIDO   SET INCLUDES
44421/228		
44421	14	Chaves hexagonais   Llaves hexagonales   Hex keys: 1.5, 2, 2.5, 3, 4, 5, 6, 7, 8, 9, 10, 11, 12, 14 mm
44422	14	Chaves hexagonais   Llaves hexagonales   Hex keys: 1/16", 5/64", 3/32", 1/8", 9/64", 5/32", 3/16", 7/32", 1/4", 5/16", 3/8", 7/16", 1/2", 9/16"



REF.	TAMANHO TAMANO   SIZE - mm	PESO   WEIGHT	Medidas   Dimensiones   Dimensions (mm)		
			A	B	C
44423/015	1.5	10 g	14	90	1,5
44423/002	2.0	10 g	16	100	2,0
44423/025	2.5	10 g	18	112	2,5
44423/003	3.0	10 g	20	126	3,0
44423/004	4.0	10 g	25	140	4,0
44423/005	5.0	20 g	28	160	5,0
44423/006	6.0	40 g	32	180	6,0
44423/007	7.0	50 g	34	190	7,0
44423/008	8.0	90 g	36	200	8,0
44423/009	9.0	110 g	38	210	9,0
44423/010	10.0	160 g	40	224	10,0
44423/011	11.0	200 g	42	236	11,0
44423/012	12.0	260 g	45	250	12,0
44423/014	14.0	380 g	56	280	14,0
44423/017	17.0	720 g	63	320	17,0

REF.	POLEGADAS PULGADAS INCHES	PESO   WEIGHT	Medidas   Dimensiones   Dimensions (mm)		
			A	B	C
44424/001	1/16"	10 g	14	90,0	1,59
44424/002	5/64"	10 g	16	100,0	1,98
44424/003	3/32"	10 g	18	112,0	2,38
44424/005	1/8"	10 g	20	126,0	3,18
44424/006	9/64"	10 g	22	136,5	3,57
44424/007	5/32"	10 g	25	140,0	3,97
44424/008	3/16"	20 g	28	160,0	4,76
44424/009	7/32"	30 g	30	170,0	5,56
44424/010	1/4"	40 g	32	180,0	6,35
44424/012	5/16"	90 g	36	200,0	7,94
44424/013	3/8"	150 g	40	224,0	9,53
44424/014	7/16"	210 g	42	236,0	11,19
44424/015	1/2"	300 g	45	250,0	12,70
44424/016	9/16"	440 g	56	280,0	14,29

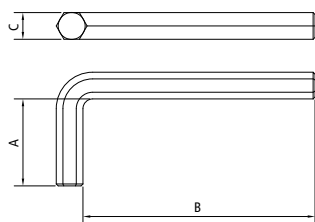

## Chaves hexagonais extra longas

### Llaves hexagonales extra-largas | Extra-long hex keys



Acabamento fosfatado.  
DIN ISO 2936 (milímetros).  
ASME B18.3 (polegadas).

Acabado fosfatado.  
DIN ISO 2936 (milímetros).  
ASME B18.3 (pulgadas).

Phosphated finishing.  
DIN ISO 2936 (millimeters).  
ASME B18.3 (inches).

### Aplicações | Aplicación | Application

- Apertar ou afrouxar parafusos com sextavado interno.
- Possui dois braços de comprimentos diferentes, ambos podem ser utilizados, dependendo da profundidade que será realizado o trabalho.
- Ajustar o aflojar tornillos con sextavados internos.
- Posee dos brazos de diferentes tamaños, ambos pueden ser utilizados dependiendo de la profundidad en la que se desea realizar el trabajo.
- Tightening or loosening hexagonal screws.
- Two arms of different lengths; either of which can be used depending on how deep the screw is situated.

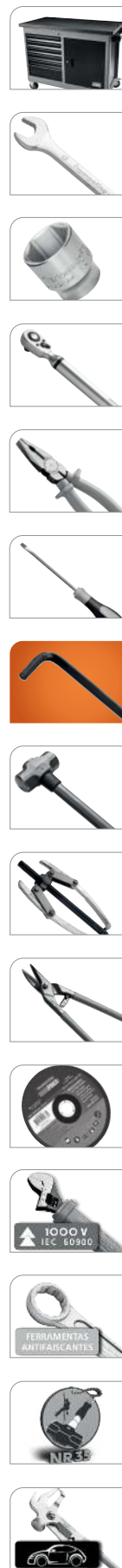

#### MATERIAL | MATERIAL | MATERIAL

#### mm

De 44423/015 até 44423/008 haste em aço ferramenta S2 e temperada.  
De 44423/015 até 44423/008 asta en acero especial S2 y templada.  
From 44423/015 up to 44423/008 hardened S2 steel blade.

De 44423/009 até 44423/017 haste em aço cromo vanádio temperada.  
De 44423/009 até 44423/017 asta en acero cromo vanadio templada.  
From 44423/009 up to 44423/017 hardened chrome vanadium steel blade.

#### polegadas / pulgadas / inches

De 44424/001 até 44424/012 haste em aço ferramenta S2 e temperada.  
De 44424/001 até 44424/012 asta en acero especial S2 y templada.  
From 44424/001 up to 44424/012 hardened S2 steel blade.

De 44424/013 até 44424/016 haste em aço cromo vanádio temperada.  
De 44424/013 até 44424/016 asta en acero cromo vanadio templada.  
From 44424/013 up to 44424/016 hardened chrome vanadium steel blade.

## Chaves hexagonais abauladas

Llaves hexagonales | Hex keys

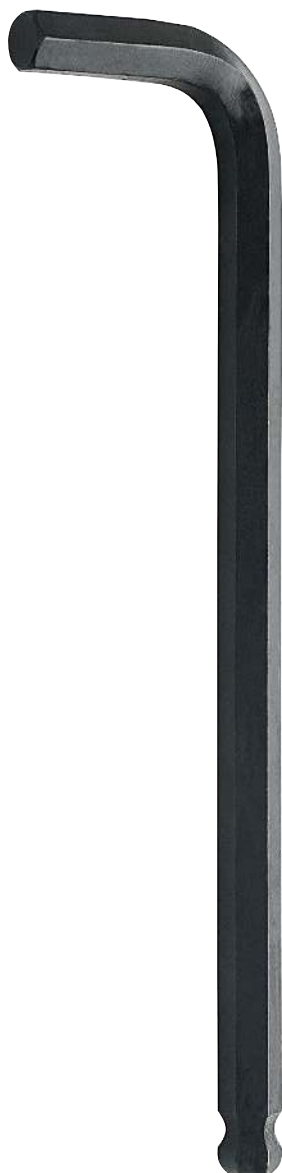

Haste em aço cromo vanádio temperada.  
Acabamento fosfatizado.  
Ponta abaulada.  
DIN ISO 2936 (milímetros).  
ASME B18.3 (polegadas).

Asta en acero cromo vanadio templado.  
Acabado fosfatado.  
Punta redonda.  
DIN ISO 2936 (milímetros).  
ASME B18.3 (pulgadas).

Hardened chrome vanadium steel blade.  
Phosphated finishing.  
Round edge.  
DIN ISO 2936 (millimeters).  
ASME B18.3 (inches).



Permite trabalhar com um ângulo de até 30° em relação ao eixo do parafuso.

Permite trabajar con un ángulo de hasta 30° con relación al eje del tornillo.

This key allows you to work on screws situated up to 30° from the vertical.

## Aplicações | Aplicación | Application

- Apertar ou afrouxar parafusos com sextavado interno.
- Possui dois braços de comprimentos diferentes, ambos podem ser utilizados, dependendo da profundidade que será realizado o trabalho.
- Ajustar o aflojar tornillos con sextavados internos.
- Posee dos brazos de diferentes tamaños, ambos pueden ser utilizados dependiendo de la profundidad en la que se desea realizar el trabajo.
- Tightening or loosening hexagonal screws.
- Two arms of different lengths; either of which can be used depending on how deep the screw is situated.

REF.	TAMANHO TAMAÑO   SIZE - mm	PESO   WEIGHT	Medidas   Dimensiones   Dimensions (mm)		
			A	B	C
44460/015	1.5	10 g	14	77	1,5
44460/002	2.0	10 g	16	83	2,0
44460/025	2.5	10 g	18	90	2,5
44460/003	3.0	10 g	20	98	3,0
44460/035	3.5	20 g	23	102	3,5
44460/004	4.0	20 g	24	106	4,0
44460/045	4.5	20 g	26	112	4,5
44460/005	5.0	30 g	28	118	5,0
44460/055	5.5	40 g	30	128	5,5
44460/006	6.0	40 g	32	137	6,0
44460/007	7.0	60 g	34	147	7,0
44460/008	8.0	80 g	36	156	8,0
44460/010	10.0	200 g	40	170	10,0
44460/012	12.0	250 g	45	207	12,0

REF.	POLEGADAS PULGADAS INCHES	PESO   WEIGHT	Medidas   Dimensiones   Dimensions (mm)		
			A	B	C
44461/005	1/8"	10 g	21,0	94,5	3,18
44461/006	9/64"	10 g	23,0	99,0	3,57
44461/007	5/32"	20 g	24,0	103,0	3,97
44461/008	3/16"	30 g	25,5	112,0	4,76
44461/009	7/32"	30 g	29,0	120,0	5,56
44461/010	1/4"	50 g	31,0	130,0	6,35
44461/012	5/16"	80 g	34,0	147,0	7,94
44461/013	3/8"	130 g	38,0	164,0	9,53

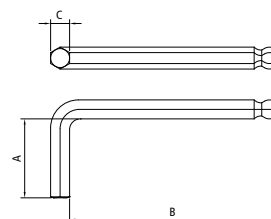

## MATERIAL | MATERIAL | MATERIAL

### mm

De 44460/015 até 44460/008 haste em aço ferramenta S2 e temperada.  
De 44460/015 até 44460/008 asta en acero especial S2 y templada.  
From 44460/015 up to 44460/008 hardened S2 steel blade.

44460/010 e 44460/012 haste em aço cromo vanádio temperada.  
44460/010 y 444260/012 asta en acero cromo vanadio templada.  
44460/010 and 44460/012 hardened chrome vanadium steel blade.

### polegadas / pulgadas / inches

De 44461/005 até 44461/012 haste em aço ferramenta S2 e temperada.  
De 44461/005 até 44461/012 asta en acero especial S2 y templada.  
From 44461/005 up to 44461/012 hardened S2 steel blade.

44461/013 haste em aço cromo vanádio temperada.  
44461/013 asta en acero cromo vanadio templada.  
44461/013 hardened chrome vanadium steel blade.





REF.	PÇS   PZS   PCS	CONTEÚDO   CONTENIDO   SET INCLUDES
<b>44460/209</b>		
44460	9	Chaves hexagonais   Llaves hexagonales   Hex keys: 1.5, 2, 2.5, 3, 4, 5, 6, 8, 10 mm
		Embalagem injetada em borracha termoplástica (PPE) Embalaje de goma termoplástica injectada (PPE) Packing injected thermoplastic rubber (PPE)

## Jogo de chaves hexagonais abauladas

### Juego de llaves hexagonales | Hex keys set



**9** PEÇAS  
PIEZAS  
PIECES

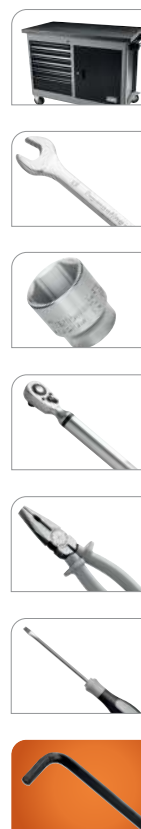

REF.	PÇS   PZS   PCS	CONTEÚDO   CONTENIDO   SET INCLUDES
<b>44460/207</b>		
44460	7	Chaves hexagonais   Llaves hexagonales   Hex keys: 1.5, 2, 2.5, 3, 4, 5, 6 mm
<b>44460/214</b>		
44460	14	Chaves hexagonais   Llaves hexagonales   Hex keys: 1.5, 2, 2.5, 3, 3.5, 4, 4.5, 5, 5.5, 6, 7, 8, 10, 12 mm
<b>44461/208</b>		
44461	8	Chaves hexagonais   Llaves hexagonales   Hex keys: 1/8", 9/64", 5/32", 3/16", 7/32", 1/4", 5/16", 3/8"

## Jogo de chaves hexagonais abauladas

### Juego de llaves hexagonales | Hex keys set



Embalagem injetada em borracha termoplástica (PPE).  
Embalaje de goma termoplástica injectada (PPE).  
Packing injected thermoplastic rubber (PPE).

## Chaves trafix

Llaves trafix | Trafix hex keys



Haste em aço ferramenta S2 temperada.  
Acabamento fosfatado.

Asta en acero especial S2 templado.  
Acabado fosfatado.

Hardened S2 steel blade.  
Phosphated finishing.

### Aplicações | Aplicación | Application

- Apertar ou afrouxar parafusos com encaixe trafix.
- Possui dois braços de comprimentos diferentes, ambos podem ser utilizados, dependendo da profundidade que será realizado o trabalho.
- Ajustar o aflojar tornillos con encaje trafix.
- Posee dos brazos de tamaños diferentes, ambos pueden ser utilizados dependiendo de la profundidad en la que será realizado el trabajo.
- Tightening or loosening trafix screws.
- Two arms of different lengths; either of which can be used depending on how deep the screw is situated.

REF.	TAMANHO TAMAÑO SIZE	PESO   WEIGHT	Medidas   Dimensiones   Dimensions (mm)		
			A	B	C
44450/006	T6	10 g	16	42	1,69
44450/007	T7	10 g	16	48	1,97
44450/008	T8	10 g	16	48	2,30
44450/009	T9	10 g	16	48	2,48
44450/010	T10	10 g	17	51	2,72
44450/015	T15	20 g	18	54	3,26
44450/020	T20	20 g	19	57	3,84
44450/025	T25	20 g	20	60	4,40
44450/027	T27	20 g	21	64	4,96
44450/030	T30	30 g	24	70	5,49
44450/040	T40	40 g	26	76	6,60
44450/045	T45	50 g	28	82	7,77
44450/050	T50	70 g	32	95	8,79
44450/055	T55	110 g	35	106	11,22
44450/060	T60	170 g	38	120	14,0

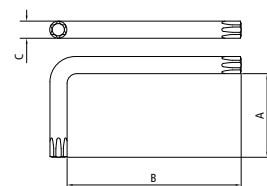

CHAVE TRAFIX - Como seleccionar LLAVE TRAFIX - Como seleccionar   TRAFIX WRENCH - How to select	
Chave Trafix correspondente Llave Trafix correspondiente   Corresponding Trafix wrench	
1,65 mm até   hasta   to 1,70 mm	T6
1,89 mm até   hasta   to 1,99 mm	T7
2,21 mm até   hasta   to 2,31 mm	T8
2,40 mm até   hasta   to 2,50 mm	T9
2,64 mm até   hasta   to 2,74 mm	T10
3,17 mm até   hasta   to 3,27 mm	T15
3,76 mm até   hasta   to 3,86 mm	T20
4,28 mm até   hasta   to 4,43 mm	T25
4,84 mm até   hasta   to 4,99 mm	T27
5,37 mm até   hasta   to 5,52 mm	T30
6,45 mm até   hasta   to 6,65 mm	T40
7,62 mm até   hasta   to 7,82 mm	T45
8,63 mm até   hasta   to 8,83 mm	T50
10,97 mm até   hasta   to 11,22 mm	T55
13 mm até   hasta   to 13,25 mm	T60



REF.	PÇS   PZS   PCS	CONTEÚDO   CONTENIDO   SET INCLUDES
<b>44450/209</b>		
44450	9	Chaves trafix   Llaves trafix   Trafix hex keys: T10, T15, T20, T25, T27, T30, T40, T45, T50
		Embalagem injetada em borracha termoplástica (PPE) Embalaje de goma termoplástica injectada (PPE) Packing injected thermoplastic rubber (PPE)

## Jogo de chaves trafix

### Juego llaves trafix | Trafix keys set



9

PEÇAS  
PIEZAS  
PIECES



REF.	PÇS   PZS   PCS	CONTEÚDO   CONTENIDO   SET INCLUDES
<b>44450/299</b>		
44450	9	Chaves trafix   Llaves trafix   Trafix hex keys: T7, T8, T9, T10, T15, T20, T25, T30, T40
<b>44450/215</b>		
44450	15	Chaves trafix   Llaves trafix   Trafix hex keys: T6, T7, T8, T9, T10, T15, T20, T25, T27, T30, T40, T45, T50, T55, T60

## Jogo de chaves trafix

### Juego llaves trafix | Trafix keys set



Embalagem injetada em borracha termoplástica (PPE).  
Embalaje de goma termoplástica injectada (PPE).  
Packing injected thermoplastic rubber (PPE).

## Estojo com chaves hexagonais e trifax

Estuche con llaves hexagonales y trifax

Hex and trifax keys case



**22** PEÇAS  
PIEZAS  
PIECES



REF.	PESO   WEIGHT	Medidas   Dimensiones   Dimensions (mm)		
		A	B	C
44450/222	840 g	155	170	57

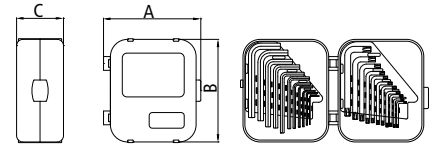

REF.	PÇS   PZS   PCS	CONTEÚDO   CONTENIDO   SET INCLUDES
44400	11	Chaves hexagonais   Llaves hexagonales   Hex keys: 1.5, 2, 2.5, 3, 4, 5, 6, 7, 8, 9, 10 mm
44450	11	Chaves Trafrix   Llaves Trafrix   Trafrix keys: T6, T7, T10, T15, T20, T25, T27, T30, T40, T45, T50
	1	Maleta plástica   Maletín plástico   Plastic case

## Jogo de chaves trifax com armação

Juego llaves trifax | Trafrix keys set



**7** PEÇAS  
PIEZAS  
PIECES



REF.	PESO   WEIGHT	Medidas   Dimensiones   Dimensions (mm)		
		A	B	C
44451/207	250 g	37,5	130	30

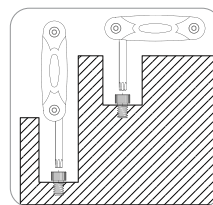
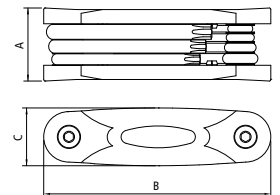

Chaves em aço cromo vanádio temperadas.

Acabamento fosfatizado.

Armação com estrutura em aço e coberta de plástico reforçado.

Llaves en acero cromo vanadio templadas.

Acabado fosfatado.

Estructura en acero cubierta de plástico reforzado.

Hardened chrome vanadium steel blades.

Phosphated finishing.

Steel core plastic holder.

REF.	PÇS   PZS   PCS	CONTEÚDO   CONTENIDO   SET INCLUDES
	7	Chaves Trafrix   Llaves Trafrix   Trafrix keys: T10, T15, T20, T25, T27, T30, T40



REF.	TAMANHO TAMAÑO SIZE	PESO   WEIGHT	Medidas   Dimensiones   Dimensions (mm)		
			A	B	C
44452/006	T6	5 g	16	90	3
44452/007	T7	5 g	16	100	3
44452/008	T8	5 g	16	100	3
44452/009	T9	5 g	16	100	3
44452/010	T10	5 g	17	138	3
44452/015	T15	3 g	18	158	5
44452/020	T20	30 g	19	178	5
44452/025	T25	35 g	20	190	5
44452/027	T27	35 g	21	200	5
44452/030	T30	55 g	24	210	6
44452/040	T40	85 g	26	215	8
44452/045	T45	90 g	28	224	8
44452/050	T50	130 g	32	232	9
44452/055	T55	240 g	35	248	12
44452/060	T60	360 g	38	278	14

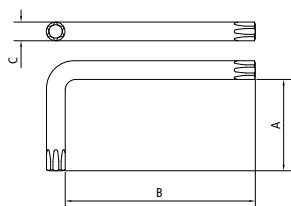

CHAVE TRAFIX - Como seleccionar  
LLAVE TRAFIX - Como seleccionar | TRAFIX WRENCH - How to select



Chave Trafix correspondente  
Llave Trafix correspondiente | Corresponding Trafix wrench

1,65 mm até   hasta   to 1,70 mm	T6
1,89 mm até   hasta   to 1,99 mm	T7
2,21 mm até   hasta   to 2,31 mm	T8
2,40 mm até   hasta   to 2,50 mm	T9
2,64 mm até   hasta   to 2,74 mm	T10
3,17 mm até   hasta   to 3,27 mm	T15
3,76 mm até   hasta   to 3,86 mm	T20
4,28 mm até   hasta   to 4,43 mm	T25
4,84 mm até   hasta   to 4,99 mm	T27
5,37 mm até   hasta   to 5,52 mm	T30
6,45 mm até   hasta   to 6,65 mm	T40
7,62 mm até   hasta   to 7,82 mm	T45
8,63 mm até   hasta   to 8,83 mm	T50
10,97 mm até   hasta   to 11,22 mm	T55
13 mm até   hasta   to 13,25 mm	T60

REF.	PÇS   PZS   PCS	CONTEÚDO   CONTENIDO   SET INCLUDES
44452/209		
44452	9	Chaves trafix longas   Llaves trafix largas   Long trafix hex keys: T10, T15, T20, T25, T27, T30, T40, T45, T50
		Embalagem injetada em borracha termoplástica (PPE) Embalaje de goma termoplástica inyectada (PPE) Packing injected thermoplastic rubber (PPE)

## Chaves trafix longas

Llaves trafix largas | Long trafix hex keys



Haste em aço ferramenta S2 temperada.  
Acabamento fosfatizado.

Asta en acero especial S2 templado.  
Acabado fosfatado.

Hardened S2 steel blade.  
Phosphated finishing.

## Aplicações | Aplicación | Application

- Apertar ou afrouxar parafusos com encaixe trafix.
- Possui dois braços de comprimentos diferentes, ambos podem ser utilizados, dependendo da profundidade que será realizado o trabalho.
- Ajustar o aflojar tornillos con encaje trafix.
- Posee dos brazos de tamaños diferentes, ambos pueden ser utilizados dependiendo de la profundidad en la que será realizado el trabajo.
- Tightening or loosening trafix screws.
- Two arms of different lengths; either of which can be used depending on how deep the screw is situated.

## Jogo de chaves trafix longas

Juego llaves trafix largas

Long trafix keys set



9 PEÇAS  
PIEZAS  
PIECES

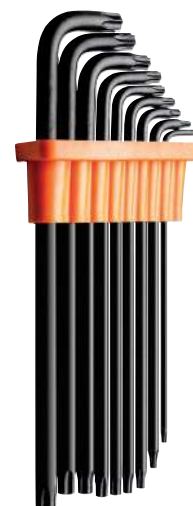

## Chaves trafix

Llaves trafix | Trafix keys

Com guia | Con guía | With guide



Haste em aço ferramenta S2 temperada.  
Acabamento fosfarizado.

Asta en acero especial S2 templado.  
Acabado fosfatado.

Hardened S2 steel blade.  
Phosphated finishing.

## Aplicações | Aplicación | Application

- Apertar ou afrouxar parafusos com encaixe trafix que tenham pino interno.
- Possui dois braços de comprimentos diferentes, ambos podem ser utilizados, dependendo da profundidade que será realizado o trabalho.
- Ajustar o aflojar tornillos con encaje trafix que tengan perno interno.
- Posee dos brazos de tamaños diferentes, ambos pueden ser utilizados dependiendo de la profundidad en la que será realizado el trabajo.
- Tightening or loosening trafix screws with internal pin.
- Two arms of different lengths; either of which can be used depending on how deep the screw is situated.

REF.	TAMANHO TAMAÑO SIZE	PESO   WEIGHT	Medidas   Dimensiones   Dimensions (mm)		
			A	B	C
44455/010	T10	10 g	17	51	2,72
44455/015	T15	10 g	18	54	3,26
44455/020	T20	20 g	19	57	3,84
44455/025	T25	20 g	20	60	4,40
44455/027	T27	20 g	21	64	4,96
44455/030	T30	20 g	24	70	5,49
44455/040	T40	40 g	26	76	6,60
44455/045	T45	50 g	28	82	7,77
44455/050	T50	70 g	32	95	8,79

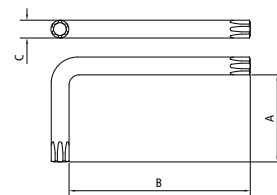

CHAVE TRAFIX - Como seleccionar		
LLAVE TRAFIX - Como seleccionar   TRAFIX WRENCH - How to select		
	Chave Trafix correspondente	
	Llave Trafix correspondiente   Corresponding Trafix wrench	
2,64 mm até   hasta   to 2,74 mm	T10	
3,17 mm até   hasta   to 3,27 mm	T15	
3,76 mm até   hasta   to 3,86 mm	T20	
4,28 mm até   hasta   to 4,43 mm	T25	
4,84 mm até   hasta   to 4,99 mm	T27	
5,37 mm até   hasta   to 5,52 mm	T30	
6,45 mm até   hasta   to 6,65 mm	T40	
7,62 mm até   hasta   to 7,82 mm	T45	
8,63 mm até   hasta   to 8,83 mm	T50	



REF.	TAMANHO TAMAÑO SIZE	PESO   WEIGHT	Medidas   Dimensiones   Dimensions (mm)		
			A	B	C
44465/004	4	20 g	20	63	4
44465/005	5	20 g	24	72	5
44465/006	6	20 g	26	76	6
44465/008	8	50 g	28	82	8
44465/010	10	80 g	31	93	10
44465/012	12	130 g	40	112	12
44465/014	14	230 g	45	125	14

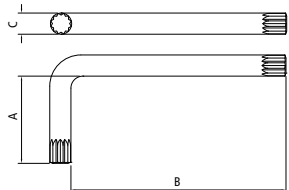

## Chaves multidentadas Llaves multidentadas | Spline hex keys



### Aplicações | Aplicación | Application

- Apertar ou afrouxar parafusos com encaixe multidentado.
- Possui dois braços de comprimentos diferentes, ambos podem ser utilizados, dependendo da profundidade que será realizado o trabalho.
- Ajustar o aflojar tornillos con encaje multidentado.
- Posee dos brazos de tamaños diferentes, ambos pueden ser utilizados dependiendo de la profundidad en la que será realizado el trabajo.
- Tightening or loosening spline slotted screws.
- Two arms of different lengths, either of which can be used depending on how deep the screw is situated.

Haste em aço cromo vanádio temperada.  
Acabamento fosfatado.

Asta en acero cromo vanadio templado.  
Acabado fosfatado.

Hardened chrome vanadium steel blade.  
Phosphated finishing.

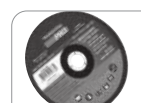

## Chave multidentada extra longa

Llave multidentada extra-larga | Extra-long spline hex keys



Haste em aço cromo vanádio temperada.  
Acabamento fosfarizado.

Asta de acero cromo vanadio templado.  
Acabado fosfatado.

Hardened chrome vanadium steel.  
Phosphated finishing.

REF.	TAMANHO TAMAÑO   SIZE - mm	PESO   WEIGHT	Medidas   Dimensiones   Dimensions (mm)		
			A	B	C
44466/008	8	120 g	47	252	8
44466/010	10	190 g	47	252	10

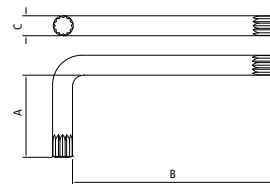

## Aplicações | Aplicación | Application

- Apertar ou afrouxar parafusos com encaixe multidentado.
- Possui dois braços de comprimentos diferentes, ambos podem ser utilizados, dependendo da profundidade que será realizado o trabalho.
- Ajustar o aflojar tornillos con encastre multidentado.
- Posee dos brazos de tamaños diferentes, ambos pueden ser utilizados dependiendo de la profundidad que será realizado el trabajo.
- Loosening and tightening spline head screws.
- Two arms of different lengths; either of which can be used depending on how deep the screw is situated.







## INFORMAÇÕES ADICIONAIS

Informaciones adicionales | Additional information

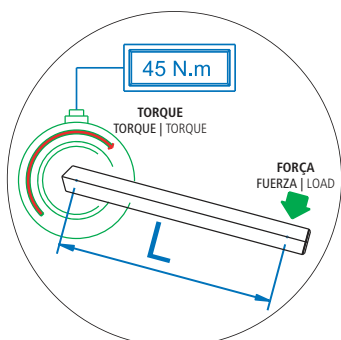

As chaves tipo L são submetidas a ensaios de torque e de dureza para analisar a resistência mecânica e atender aos valores da norma específica. Para exemplificar, a chave hexagonal supera os valores da norma DIN ISO 2936.

Las llaves hexagonales son sometidas a ensayos de torque y dureza para analizar la resistencia mecánica y atender a los valores de la norma específica. Para ejemplificar la llave hexagonal supera los valores de la norma DIN ISO 2936.

The hex keys are subjected to torque and hardness test to analyse their mechanical resistance and to ensure they meet specific standards. For example, the hex key exceeds the values of standard DIN ISO 2936.

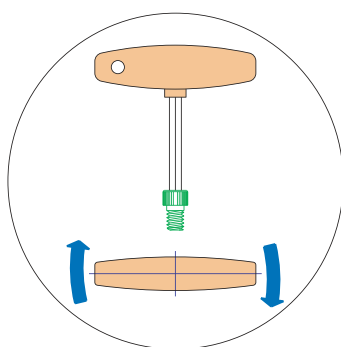

A chave cabo T possui o cabo de plástico injetado no braço curto da chave para ampliar a aplicação de torque.

Las llaves hexagonales mango T posee el mango de plástico inyectado en el brazo corto de las llaves para alargar la aplicación del torque.

The T handle hex keys have the plastic handle injected on the short arm of the wrench to increase the torque application.

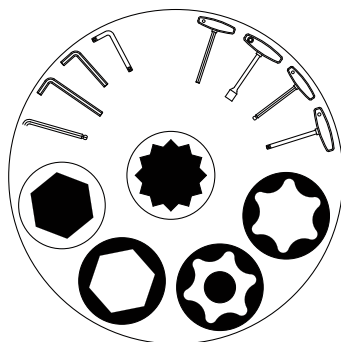

Esta família de chaves já possui uma grande variedade de formas, perfis de pontas e comprimentos para as diversas aplicações automotivas e industriais.

Esta familia de llaves ya posee una gran variedad de formas, perfiles de puntas y largo para las diversas aplicaciones en los sectores automotriz e industrial.

This family of hex keys comes in a variety of profiles, to ensure that they are suitable for all applications in the automotive industry as well as other industries.

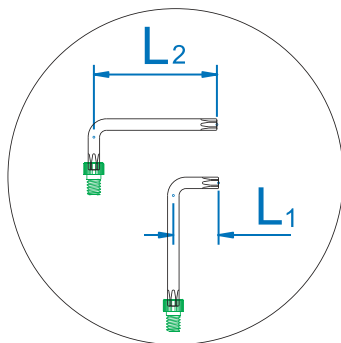

As chaves tipo L possuem dois braços de comprimentos diferentes ( $L_1$  e  $L_2$ ), e ambas extremidades podem ser utilizadas dependendo do local onde será realizado o trabalho. Ao utilizar o braço mais longo ( $L_2$ ) tem-se mais torque, enquanto o braço mais curto ( $L_1$ ) promove uma operação mais rápida.

Las llaves hexagonales poseen dos brazos de largo diferentes ( $L_1$  y  $L_2$ ), y las dos extremidades pueden ser utilizadas dependiendo del sitio donde será realizado el trabajo. Al utilizar el brazo más largo ( $L_2$ ) se tiene más torque, mientras el brazo más corto ( $L_1$ ) proporciona una operación más rápida.

The L type hex keys have two arms of different lengths ( $L_1$  and  $L_2$ ), and both ends can be used depending on the work being done. Using the longer arm ( $L_2$ ) you'll have more torque, while using the shorter arm ( $L_1$ ) you'll have a quicker operation.

As chaves cabo T e tipo L são produzidas e testadas conforme normas específicas. Las llaves hexagonales son producidas y testadas bajo normas internacionales. Hex keys are produced and tested according to international standards.

